

SONY®

3-082-036-11(2)

# CD/DVD Player

## Operating Instructions

### Customers in the U.S.A

#### Owner's Record

The model and serial numbers are located at the rear of the unit. Record the serial number in the space provided below. Refer to them whenever you call upon your Sony dealer regarding this product.

Model No. DVP-NC555ES

Serial No. \_\_\_\_\_

### Customers in Canada

If this product is not working properly, please call 1-877-602-2008 for **Peace of Mind Warranty Replacement service.**

For other product related questions please contact our **Customer Information Service Centre** at 1-877-899-7669 or write to us at: Customer Information Service 115 Gordon Baker Road, Toronto, Ontario, M2H 3R6



## DVP-NC555ES

© 2003 Sony Corporation

## WARNING

To prevent fire or shock hazard, do not expose the unit to rain or moisture. To avoid electrical shock, do not open the cabinet. Refer servicing to qualified personnel only.

The AC power cord must be changed only at a qualified service shop.

### CAUTION

The use of optical instruments with this product will increase eye hazard. As the laser beam used in this CD/DVD player is harmful to eyes, do not attempt to disassemble the cabinet.

Refer servicing to qualified personnel only.

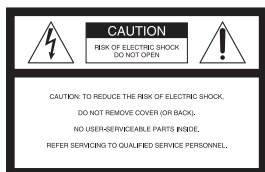

This symbol is intended to alert the user to the presence of uninsulated “dangerous voltage” within the product’s enclosure that may be of sufficient magnitude to constitute a risk of electric shock to persons.



This symbol is intended to alert the user to the presence of important operating and maintenance (servicing) instructions in the literature accompanying the appliance.

### CAUTION

You are cautioned that any change or modifications not expressly approved in this manual could void your authority to operate this equipment.

### Note

This equipment has been tested and found to comply with the limits for a Class B digital device, pursuant to Part 15 of the FCC Rules. These limits are designed to provide reasonable protection against harmful interference in a residential installation. This equipment generates, uses, and can radiate radio frequency energy and, if not installed and used in accordance with the instructions, may cause harmful interference to radio communications. However, there is no guarantee that interference will not occur in a particular installation. If this equipment does cause harmful interference to radio or television reception, which can be determined by turning the equipment off and on, the user is encouraged to try to correct the interference by one or more of the following measures:

- Reorient or relocate the receiving antenna.
- Increase the separation between the equipment and receiver.
- Connect the equipment into an outlet on a circuit different from that to which the receiver is connected.
- Consult the dealer or an experienced radio/TV technician for help.

## Welcome!

Thank you for purchasing this Sony CD/DVD Player. Before operating this player, please read this manual thoroughly and retain it for future reference.

---

# Precautions

## On safety

- Caution – The use of optical instruments with this product will increase eye hazard.
- To prevent fire or shock hazard, do not place objects filled with liquids, such as vases, on the apparatus.
- Should any solid object or liquid fall into the cabinet, unplug the player and have it checked by qualified personnel before operating it any further.

## On power sources

- The player is not disconnected from the AC power source as long as it is connected to the wall outlet, even if the player itself has been turned off.
- If you are not going to use the player for a long time, be sure to disconnect the player from the wall outlet. To disconnect the AC power cord, grasp the plug itself; never pull the cord.

## On placement

- Place the player in a location with adequate ventilation to prevent heat build-up in the player.
- Do not place the player on a soft surface such as a rug that might block the ventilation holes.
- Do not place the player in a location near heat sources, or in a place subject to direct sunlight, excessive dust, or mechanical shock.
- Do not install the player in an inclined position. It is designed to be operated in a horizontal position only.
- Keep the player away from equipment with strong magnets, such as microwave ovens, or large loudspeakers.
- Do not place heavy objects on the player.

## On operation

- If the player is brought directly from a cold to a warm location, or is placed in a very damp room, moisture may condense on the lenses inside the player. Should this occur, the player may not operate properly. In this case, remove the disc and leave the player turned on for about half an hour until the moisture evaporates.

- When you move the player, take out any discs. If you don't, the disc may be damaged.

## On adjusting volume

Do not turn up the volume while listening to a section with very low level inputs or no audio signals. If you do, the speakers may be damaged when a peak level section is played.

## On cleaning

Clean the cabinet, panel, and controls with a soft cloth slightly moistened with a mild detergent solution. Do not use any type of abrasive pad, scouring powder or solvent such as alcohol or benzine.

## On cleaning discs

Do not use a commercially available cleaning disc. It may cause a malfunction.

### IMPORTANT NOTICE

Caution: This player is capable of holding a still video image or on-screen display image on your television screen indefinitely. If you leave the still video image or on-screen display image displayed on your TV for an extended period of time you risk permanent damage to your television screen. Plasma display panel television and projection televisions are especially susceptible to this.

## On transporting the player

Before transporting the player, follow the procedure below to return the internal mechanisms to their original positions.

- 1 Remove all the discs from the disc tray.
- 2 Press ▲ to close the disc tray. Make sure that "NO DISC" appears on the front panel display.
- 3 Press I/⏻ to turn off the player. The player enters standby mode.
- 4 Disconnect the AC power cord.

If you have any questions or problems concerning your player, please consult your nearest Sony dealer.

# Table of Contents

WARNING . . . . .	2
Welcome! . . . . .	2
Precautions . . . . .	3
About This Manual . . . . .	6
This Player Can Play the Following Discs . . . . .	6
Notes About the Discs . . . . .	8
Index to Parts and Controls . . . . .	9
Guide to the Control Menu Display . . . . .	13
<hr/>	
<b>Hookups . . . . .</b>	<b>16</b>
Hooking Up the Player . . . . .	16
Step 1: Unpacking . . . . .	16
Step 2: Preparing the Remote . . . . .	16
Step 3: Connecting the Video Cords . . . . .	18
Step 4: Connecting the Audio Cords . . . . .	21
Step 5: Connecting the Power Cord . . . . .	27
Step 6: Quick Setup . . . . .	27
<hr/>	
<b>Playing Discs . . . . .</b>	<b>31</b>
Playing Discs . . . . .	31
Resuming Playback From the Point Where You Stopped the Disc (Multi-disc Resume) . . . . .	34
Using the DVD's Menu . . . . .	35
Selecting "ORIGINAL" or "PLAY LIST" on a DVD-RW Disc . . . . .	35
Selecting a Playback Area for a Super Audio CD Disc . . . . .	36
Playing VIDEO CDs With PBC Functions (PBC Playback) . . . . .	37
Playing an MP3 Audio Track . . . . .	38
Various Play Mode Functions (Program Play, Shuffle Play, Repeat Play, A-B Repeat Play) . . . . .	41
<hr/>	
<b>Searching for a Scene . . . . .</b>	<b>46</b>
Searching for a Particular Point on a Disc (Shuttle mode, Jog mode, Freeze Frame) . . . . .	46
Searching for a Title/Chapter/Track/Scene, etc. . . . .	47
Searching by Scene (PICTURE NAVIGATION) . . . . .	49
<hr/>	
<b>Viewing Information About the Disc . . . . .</b>	<b>50</b>
Checking the Playing Time and Remaining Time . . . . .	50
Checking the Play Information . . . . .	52
<hr/>	
<b>Sound Adjustments . . . . .</b>	<b>54</b>
Changing the Sound . . . . .	54
SURROUND Mode Settings . . . . .	56

---

<b>Enjoying Movies</b> . . . . .	<b>57</b>
Changing the Angles . . . . .	57
Displaying the Subtitles . . . . .	57
Adjusting the Playback Picture (VIDEO CONTROL) . . . . .	58

---

<b>Using Various Additional Functions</b> . . . . .	<b>62</b>
Locking Discs (CUSTOM PARENTAL CONTROL, PARENTAL CONTROL). . . . .	62
Operation Sound Effects (Sound Feedback) . . . . .	66
Controlling Your TV or AV Amplifier (Receiver) With the Supplied Remote . . . . .	67

---







<b>Settings and Adjustments</b> . . . . .	<b>69</b>
Using the Setup Display. . . . .	69
Setting the Display or Sound Track Language (LANGUAGE SETUP) . . . . .	70
Settings for the Display (SCREEN SETUP). . . . .	71
Custom Settings (CUSTOM SETUP). . . . .	73
Settings for the Sound (AUDIO SETUP) . . . . .	74
Settings for the Speakers (SPEAKER SETUP). . . . .	76

---

<b>Additional Information</b> . . . . .	<b>79</b>
Troubleshooting . . . . .	79
Self-diagnosis Function (When letters/numbers appear in the display). . . . .	81
Glossary . . . . .	82
Specifications . . . . .	85
Language Code List . . . . .	86
Index . . . . .	87





## About This Manual

- Instructions in this manual describe the controls on the remote. You can also use the controls on the player if they have the same or similar names as those on the remote.
- “DVD” may be used as a general term for DVD VIDEOS, DVD-RWs/DVD-Rs and DVD+RWs/DVD+Rs.
- The meanings of the icons used in this manual are described below:

Icon	Meaning
	Functions available for DVD VIDEOS and DVD-RWs/DVD-Rs in video mode or DVD+RWs/DVD+Rs
	Functions available for DVD-RWs in VR (Video Recording) mode
	Functions available for VIDEO CDs, Super VCDs or CD-Rs/CD-RWs in video CD format or Super VCD format
	Functions available for Super Audio CDs
	Functions available for DATA CDs (CD-ROMs/CD-Rs/CD-RWs containing MP3* audio tracks)
	Functions available for music CDs or CD-Rs/CD-RWs in music CD format

\* MP3 (MPEG1 Audio Layer 3) is a standard format defined by ISO (International Standard Organization)/MPEG which compresses audio data.

## This Player Can Play the Following Discs

Format of discs	
DVD VIDEO (page 82)	
DVD-RW (page 82)	
Super Audio CD (page 84)	
VIDEO CD	
Music CD	

“DVD VIDEO” and “DVD-RW” are trademarks.

## Region code

Your player has a region code printed on the back of the unit and only will play DVD VIDEO discs (playback only) labeled with identical region codes. This system is used to protect copyrights.

DVD VIDEOS labeled  will also play on this player.

If you try to play any other DVD VIDEO, the message “Playback prohibited by area limitations.” will appear on the TV screen. Depending on the DVD VIDEO, no region code indication may be labeled even though playing the DVD VIDEO is prohibited by area restrictions.



---

## Example of discs that the player cannot play

The player cannot play the following discs:

- All CD-ROMs (including PHOTO CDs)/CD-Rs/CD-RWs other than those recorded in the following formats:
    - music CD format
    - video CD format
    - MP3 format that conforms to ISO9660\* Level 1/Level 2, or its extended format, Joliet
  - Data part of CD-Extras
  - DVD-ROMs
  - DVD Audio discs
- \* A logical format of files and folders on CD-ROMs defined by ISO (International Standard Organization).

Also, the player cannot play the following discs:

- A DVD VIDEO with a different region code.
- A disc recorded in a color system other than NTSC, such as PAL or SECAM (this player conforms to the NTSC color system).
- A disc that has a non-standard shape (e.g., card, heart).
- A disc with paper or stickers on it.
- A disc that has the adhesive of cellophane tape or a sticker still left on it.

### Notes

- **Notes about DVD-RWs/DVD-Rs, DVD+RWs/DVD+Rs, or CD-Rs/CD-RWs**

Some DVD-RWs/DVD-Rs, DVD+RWs/DVD+Rs, or CD-Rs/CD-RWs cannot be played on this player due to the recording quality or physical condition of the disc, or the characteristics of the recording device and authoring software.

The disc will not play if it has not been correctly finalized. Also, images in DVD-RWs with CPRM\* protection may not be played if they contain a copy protection signal. "Copyright lock" appears on the screen. For more information, see the operating instructions for the recording device.

Note that discs created in the Packet Write format cannot be played.

\* CPRM (Content Protection for Recordable Media) is a coding technology that protects copyright for images.

- **Music discs encoded with copyright protection technologies**

This product is designed to playback discs that conform to the Compact Disc (CD) standard. Recently, various music discs encoded with copyright protection technologies are marketed by some record companies. Please be aware that among those discs, there are some that do not conform to the CD standard and may not be playable by this product.

---

## Note on playback operations of DVDs and VIDEO CDs

Some playback operations of DVDs and VIDEO CDs may be intentionally set by software producers. Since this player plays DVDs and VIDEO CDs according to the disc contents the software producers designed, some playback features may not be available. Also, refer to the instructions supplied with the DVDs or VIDEO CDs.

---

## Copyrights

This product incorporates copyright protection technology that is protected by U.S. patents and other intellectual property rights. Use of this copyright protection technology must be authorized by Macrovision, and is intended for home and other limited viewing uses only unless otherwise authorized by Macrovision. Reverse engineering or disassembly is prohibited.

---

## Notes About the Discs

- To keep the disc clean, handle the disc by its edge. Do not touch the surface.



- Do not expose the disc to direct sunlight or heat sources such as hot air ducts, or leave it in a car parked in direct sunlight as the temperature may rise considerably inside the car.
- After playing, store the disc in its case.
- Clean the disc with a cleaning cloth. Wipe the disc from the center out.



- Do not use solvents such as benzine, thinner, commercially available cleaners, or anti-static spray intended for vinyl LPs.





## Front panel display

### When playing back a DVD VIDEO/DVD-RW

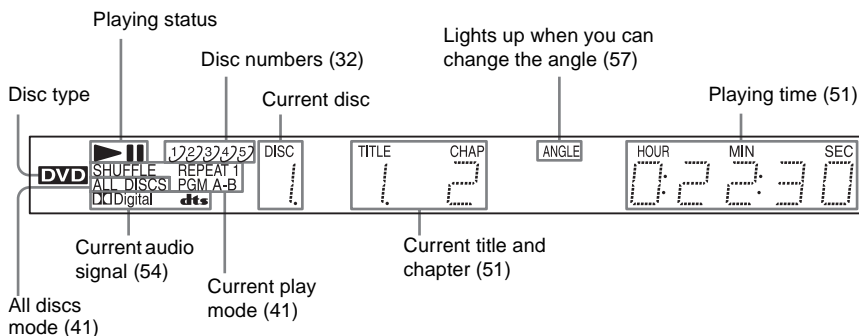

### When playing back a VIDEO CD with Playback Control (PBC) (37)

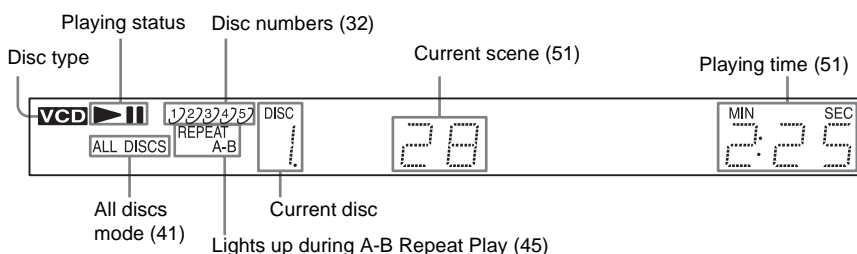

### When playing back a CD, Super Audio CD, DATA CD (MP3 audio), or VIDEO CD (without PBC)

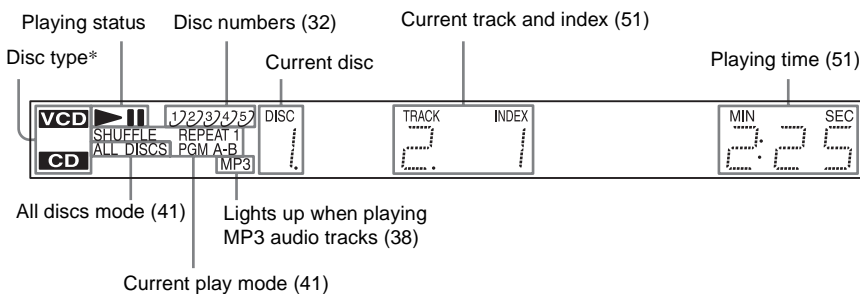

\* When playing the HD layer of Super Audio CD discs, the disc type is not displayed.

#### Hint

You can adjust the lighting of the front panel display by setting "DIMMER" in "CUSTOM SETUP" (page 73). When "DIMMER" is set to "AUTO OFF" or "OFF (FL OFF)," the FL OFF indicator is lit on the player.

## Rear panel

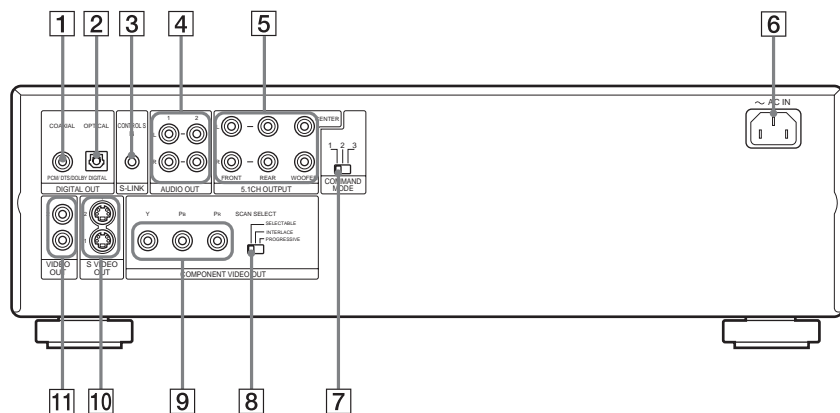

- |  |   |
|--|---|
| <p><b>1</b> DIGITAL OUT (COAXIAL) jack (23) (24) (25)</p> <p><b>2</b> DIGITAL OUT (OPTICAL) jack (23) (24) (25)</p> <p><b>3</b> S-LINK/CONTROL S IN jack (19)</p> <p><b>4</b> AUDIO OUT L/R 1/2 jacks (22) (23) (24)</p> <p><b>5</b> 5.1CH OUTPUT jacks (25)</p> <p><b>6</b> AC IN terminal (16)</p> | <p><b>7</b> COMMAND MODE switch (1, 2, 3) (17)</p> <p><b>8</b> COMPONENT VIDEO OUT/SCAN SELECT switch (72)</p> <p><b>9</b> COMPONENT VIDEO OUT (Y, Pb, Pr) jacks (18)</p> <p><b>10</b> S VIDEO OUT 1/2 jacks (18)</p> <p><b>11</b> VIDEO OUT 1/2 jacks (18)</p> |
|--|---|

## Remote

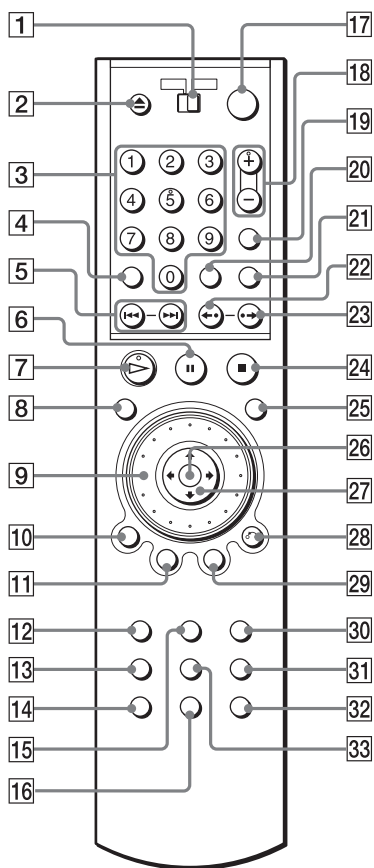

- 1** TV/DVD switch (67)
- 2** ▲ OPEN/CLOSE button (32)
- 3** Number buttons (35)  
The number 5 button has a tactile dot.\*
- 4** CLEAR button (41)
- 5** ◀◀/▶▶ PREV/NEXT (previous/next) buttons (32)
- 6** ⏸ PAUSE button (32)
- 7** ▷ PLAY button (31)  
The ▷ button has a tactile dot.\*
- 8** PICTURE NAVI (picture navigation) button (49)
- 9** Click shuttle (46)
- 10** DISPLAY button (13)

- 11** TOP MENU button (35)
- 12** AUDIO button (54)
- 13** SHUFFLE button (43)
- 14** SACD MULTI/2CH (Super Audio CD multi/2 channel) button (36)
- 15** SUBTITLE button (57)
- 16** SACD (Super Audio CD)/CD button (37)
- 17** ⏻ (on/standby) button (31)
- 18** VOL (volume) +/- buttons (67)  
The + button has a tactile dot.\*
- 19** TV/VIDEO button (67)/TIME/TEXT button (50)
- 20** ENTER button
- 21** DISC SKIP button (31)
- 22** ◀•/◀◀ INSTANT REPLAY/STEP button (32) (47)
- 23** •▶/▶▶ INSTANT SEARCH/STEP button (32) (47)
- 24** ■ STOP button (32)
- 25** JOG button (47)
- 26** ENTER button (27)
- 27** ◀/↑/↓/▶ buttons (32)
- 28** ⏪ RETURN button (33)
- 29** MENU button (35) (38)
- 30** ANGLE button (57)
- 31** A-B button (45)
- 32** VIDEO CONTROL button (58)
- 33** REPEAT button (44)

\* Use the tactile dot as a reference when operating the player.

# Guide to the Control Menu Display

Use the Control Menu to select a function and to view related information. Press DISPLAY repeatedly to turn on or change the Control Menu display as follows:

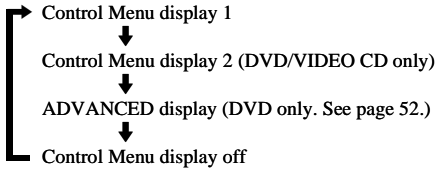

## 💡 Hint

You can skip the ADVANCED display by setting “OFF” under “ADVANCED” in the Control Menu (page 52).

## Control Menu Display

The Control Menu display 1 and 2 will show different items depending on the disc type. For details, please refer to the pages in parentheses.



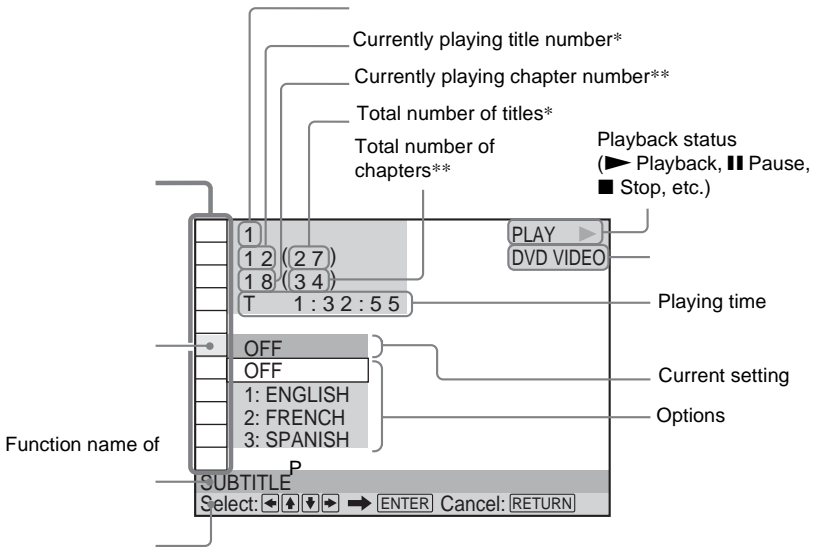











Example: Control Menu display 1 when playing a DVD VIDEO.











\* Displays the scene number for VIDEO CDs (PBC is on), track number for VIDEO CDs/Super Audio CDs/CDs, album number for DATA CDs.



\*\* Displays the index number for VIDEO CDs/Super Audio CDs/CDs, MP3 audio track number for DATA CDs.

## List of Control Menu Items

Item	Item Name, Function, Relevant Disc Type
	<b>DISC (page 47)</b> Selects the disc to be played. <b>DVD-V DVD-RW VCD SA-CD CD DATA CD</b>
	<b>TITLE (page 47)/SCENE (page 47)/TRACK (page 47)</b> Selects the title, scene, or track to be played. <b>DVD-V DVD-RW VCD</b>
	<b>CHAPTER (page 47)/INDEX (page 47)</b> Selects the chapter or index to be played. <b>DVD-V DVD-RW VCD</b>
	<b>ALBUM (page 38)</b> Selects the album to be played. <b>DATA CD</b>
	<b>TRACK (page 47)</b> Selects the track to be played. <b>SA-CD CD DATA CD</b>
	<b>INDEX (page 47)</b> Selects the index to be played. <b>SA-CD CD</b>
	<b>ORIGINAL/PLAY LIST (page 35)</b> Selects the type of titles (DVD-RW) to be played, the ORIGINAL one, or an edited PLAY LIST. <b>DVD-RW</b>
	<b>TIME/TEXT (page 47)</b> Checks the elapsed time and the remaining playback time. Input the time code for picture and music searching. Displays the DVD/Super Audio CD/CD text, or the DATA CD's track name. <b>DVD-V DVD-RW VCD SA-CD CD DATA CD</b>
	<b>MULTI/2CH (page 36)</b> Selects the playback area on Super Audio CDs when available. <b>SA-CD</b>
	<b>AUDIO (page 54)</b> Changes the audio setting. <b>DVD-V DVD-RW VCD CD DATA CD</b>
	<b>SUBTITLE (page 57)</b> Displays the subtitles. Changes the subtitle language. <b>DVD-V DVD-RW</b>
	<b>ANGLE (page 57)</b> Changes the angle. <b>DVD-V</b>
	<b>SURROUND (page 56)</b> Selects the surround functions. <b>DVD-V DVD-RW VCD CD DATA CD</b>
	<b>ADVANCED (page 52)</b> Displays the information (bit rate or layer) of the disc currently playing. <b>DVD-V DVD-RW</b>
	<b>PARENTAL CONTROL (page 62)</b> Set to prohibit playback on this player. <b>DVD-V VCD SA-CD CD</b>

	<p><b>SETUP (page 69)</b>  <b>QUICK Setup (page 27)</b>          Use Quick Setup to choose the desired language of the on-screen display, the aspect ratio of the TV, the audio output signal, and the size of the speakers you are using.  <b>CUSTOM Setup</b>          In addition to the Quick Setup setting, you can adjust various other settings.  <b>RESET</b>          Returns the settings in “SETUP” to the default setting.</p> <p style="text-align: right;"><b>DVD-V DVD-RW VCD SA-CD CD DATA CD</b></p>
 	<p><b>ALL DISCS/ONE DISC (page 41)</b>          Selects All Discs or One Disc mode.</p> <p style="text-align: right;"><b>DVD-V DVD-RW VCD SA-CD CD DATA CD</b></p>
	<p><b>PROGRAM (page 41)</b>          Selects the disc, title, chapter, or track to play in the order you want.</p> <p style="text-align: right;"><b>DVD-V VCD SA-CD CD</b></p>
	<p><b>SHUFFLE (page 43)</b>          Plays the disc, title, chapter, or track in random order.</p> <p style="text-align: right;"><b>DVD-V DVD-RW VCD SA-CD CD DATA CD</b></p>
	<p><b>REPEAT (page 44)</b>          Plays the entire disc (all titles/all tracks/all albums) repeatedly or one title/chapter/track/album repeatedly.</p> <p style="text-align: right;"><b>DVD-V DVD-RW VCD SA-CD CD DATA CD</b></p>
	<p><b>A-B REPEAT (page 45)</b>          Specifies the parts you want to play repeatedly.</p> <p style="text-align: right;"><b>DVD-V DVD-RW VCD SA-CD CD</b></p>
	<p><b>VIDEO CONTROL (page 58)</b>          Adjusts the video signal from the player in various ways.          Select the setting that suits the program you are watching. Or, make detailed adjustments to each element of the picture qualities, such as brightness, color, noise, sharpness, and many others.</p> <p style="text-align: right;"><b>DVD-V DVD-RW VCD</b></p>
	<p><b>PICTURE NAVIGATION (page 49)</b>          Divides the screen into 9 subscreens to help you find the scene you want quickly.</p> <p style="text-align: right;"><b>DVD-V VCD</b></p>

 **Hint**

The Control Menu icon indicator lights up in green  →  when you select any item except “OFF.” (“SURROUND,” “PROGRAM,” “SHUFFLE,” “REPEAT,” “A-B REPEAT” only.) The “ANGLE” indicator lights up in green only when the angles can be changed. The “VIDEO CONTROL” indicator lights up in green when any setting other than “STANDARD” is selected.

# Hooking Up the Player

Follow steps 1 to 6 to hook up and adjust the settings of the player.

### Notes

- Plug cords securely to prevent unwanted noise.
- Refer to the instructions supplied with the components to be connected.
- You cannot connect this player to a TV that does not have a video input jack.
- Be sure to disconnect the power cord of each component before connecting.

## Step 1: Unpacking

Check that you have the following items:

- Audio/video cord (pinplug × 3 ↔ pinplug × 3) (1)
- Power cord (1)
- Remote commander (remote) (1)
- Size AA (R6) batteries (2)

### Connecting the power cord

Connect the supplied power cord to the AC IN terminal of the player.

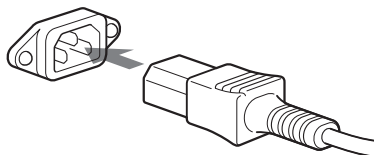

## Step 2: Preparing the Remote

You can control the player using the supplied remote. Insert two Size AA (R6) batteries by matching the ⊕ and ⊖ ends on the batteries to the markings inside the compartment. When using the remote, point it at the remote sensor  on the player.

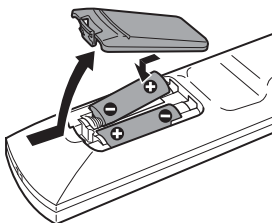





# Step 3: Connecting the Video Cords

Connect this player to your TV monitor, projector, or AV amplifier (receiver) using a video cord. Select one of the patterns **A** through **C**, according to the input jack on your TV monitor, projector, or AV amplifier (receiver). In order to view progressive signal (480p) pictures with a compatible TV, projector, or monitor, you must use pattern **C**.

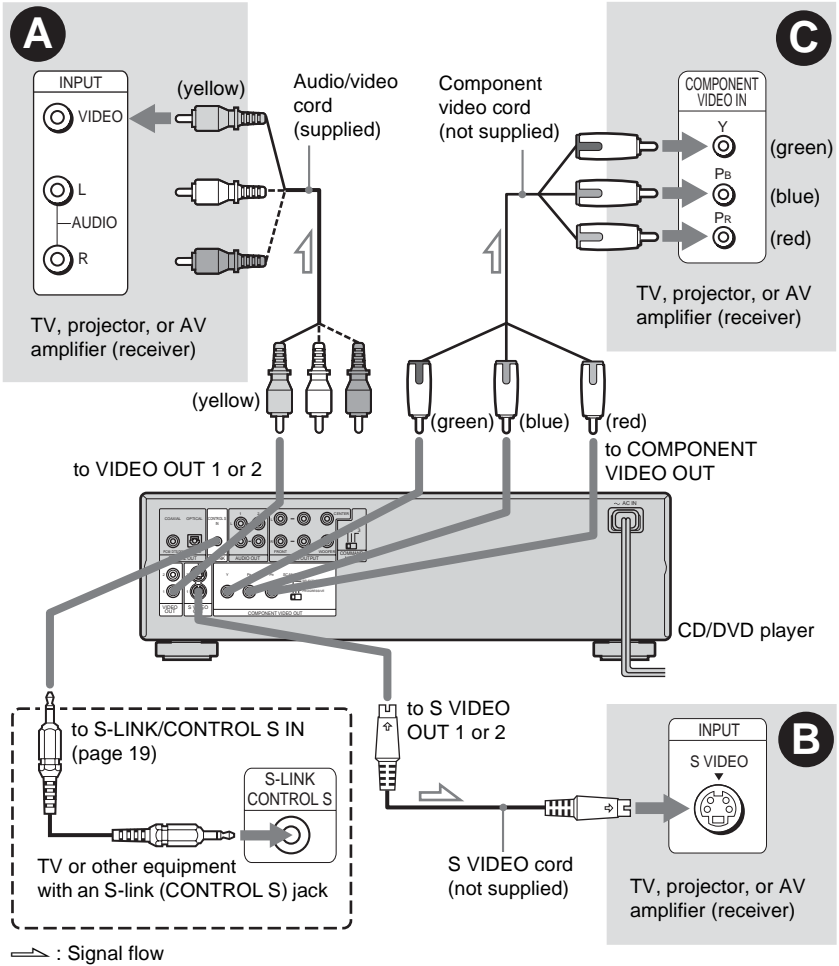

### **A** If you are connecting to a video input jack

Connect the yellow plug of the audio/video cord (supplied) to the yellow (video) jacks. You will enjoy standard quality images.



Use the red and white plugs to connect to the audio input jacks (page 22). (Do this if you are connecting to a TV only.)

### **B** If you are connecting to an S VIDEO input jack

Connect an S VIDEO cord (not supplied). You will enjoy high quality images.



### **C** If you are connecting to a monitor, projector, or AV amplifier (receiver) having component video input jacks (Y, P<sub>B</sub>, P<sub>R</sub>)

Connect the component via the COMPONENT VIDEO OUT jacks using a component video cord (not supplied) or three video cords (not supplied) of the same kind and length. You will enjoy accurate color reproduction and high quality images. If your TV accepts progressive (480p) format signals, you must use this connection and set “COMPONENT OUT” to “PROGRESSIVE” in “SCREEN SETUP” (page 72).

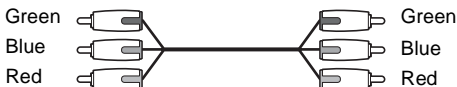

#### When connecting to a wide screen TV

Depending on the disc, the image of some discs may not fit your TV screen. If you want to change the aspect ratio, please refer to page 71.

#### **Hint**

If your TV has an S-LINK (CONTROL S) jack, you can control the player by operating the remote toward the TV. This feature is convenient when you placed the player and the TV away from each other. After connecting the player with other components according to the above **A**, **B**, or **C**, connect the TV via the S-LINK/CONTROL S IN jack using an S-link (control S) cord (not supplied). Refer to the instructions supplied with the TV to be connected.



## Notes

- Connect the player directly to the TV. If you pass the player signals via the VCR, you may not receive a clear image on the TV screen.

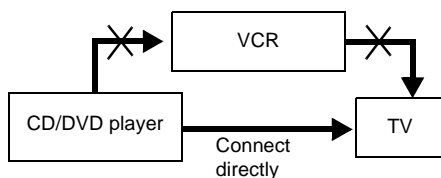

- Consumers should note that not all high definition television sets are fully compatible with this product and may cause artifacts to be displayed in the picture. In case of 480 progressive scan picture problems, it is recommended that the user switch the connection to the 'standard definition' output. If there are questions regarding our TV set compatibility with this model 480p DVD player, please contact our customer service center.

## Step 4: Connecting the Audio Cords

Refer to the chart below to select the connection that best suits your system. Be sure to also read the instructions for the components you wish to connect.

### Select a connection

Select one of the following connections, **A** through **D**.

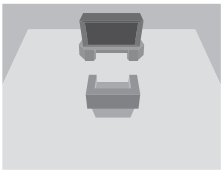
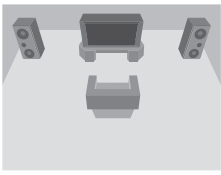
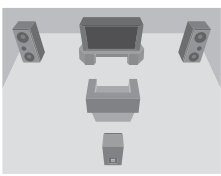
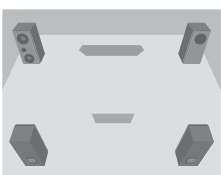
Components to be connected	Connection	Your setup (example)
<b>TV</b> • Surround effects: None	<b>A</b> (page 22)	
<b>Stereo amplifier (receiver) and two speakers</b> • Surround effects: None or <b>MD deck/DAT deck</b> • Surround effects: None	<b>B</b> (page 23)	
<b>AV amplifier (receiver) having a Dolby* Surround (Pro Logic) decoder and 3 to 6 speakers</b> • Surround effects: Dolby Surround (Pro Logic) (page 82)	<b>C</b> (page 24)	
<b>AV amplifier (receiver) with 5.1 ch input jacks and 4 to 6 speakers</b> • Surround effects: – Dolby Digital (5.1 ch) (page 82) – DTS (5.1 ch) (page 82) – Super Audio CD Multi channel (page 84) or <b>AV amplifier (receiver) with digital input jacks having a Dolby or DTS** decoder and 6 speakers</b> • Surround effects: – Dolby Digital (5.1ch) (page 82) – DTS (5.1ch) (page 82)	<b>D</b> (page 25)	

#### Hint

If you connect an AV amplifier (receiver) that conforms to the 96 kHz sampling frequency, use connection

\* Manufactured under license from Dolby Laboratories. “Dolby,” “Pro Logic,” and the double-D symbol are trademarks of Dolby Laboratories.

\*\* “DTS” and “DTS Digital Surround” are registered trademarks of Digital Theater Systems, Inc.

## A Connecting to your TV

This connection will use your TV speakers for sound.

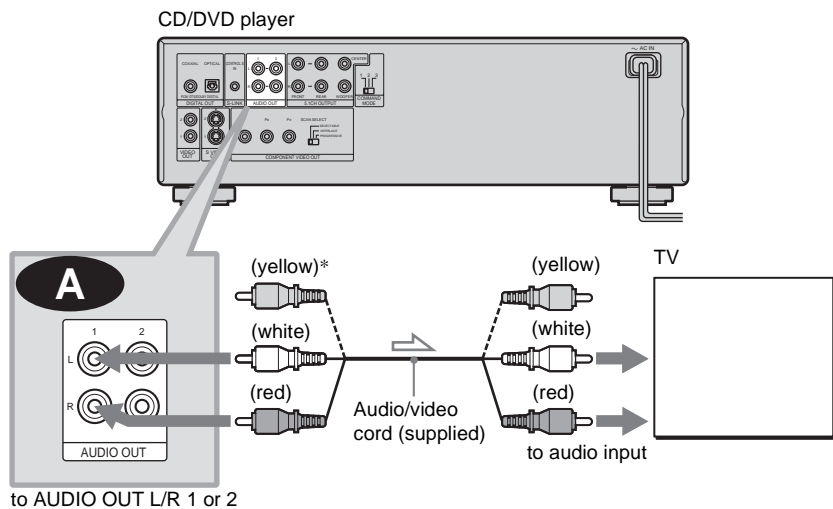

➡ : Signal flow

\* The yellow plug is used for video signals (page 18).

### Hint

When connecting to a monaural TV, use a stereo-mono conversion cord (not supplied). Connect the AUDIO OUT L/R 1/2 jacks to the TV's audio input jack.

## **B** Connecting to a stereo amplifier (receiver) and 2 speakers/Connecting to an MD deck or DAT deck

If the stereo amplifier (receiver) has audio input jacks L and R only, use **B-1**. If the amplifier (receiver) has a digital input jack, or when connecting to an MD deck or DAT deck, use **B-2**. In this case, you can also connect the player directly to the MD deck or DAT deck without using your stereo amplifier (receiver).

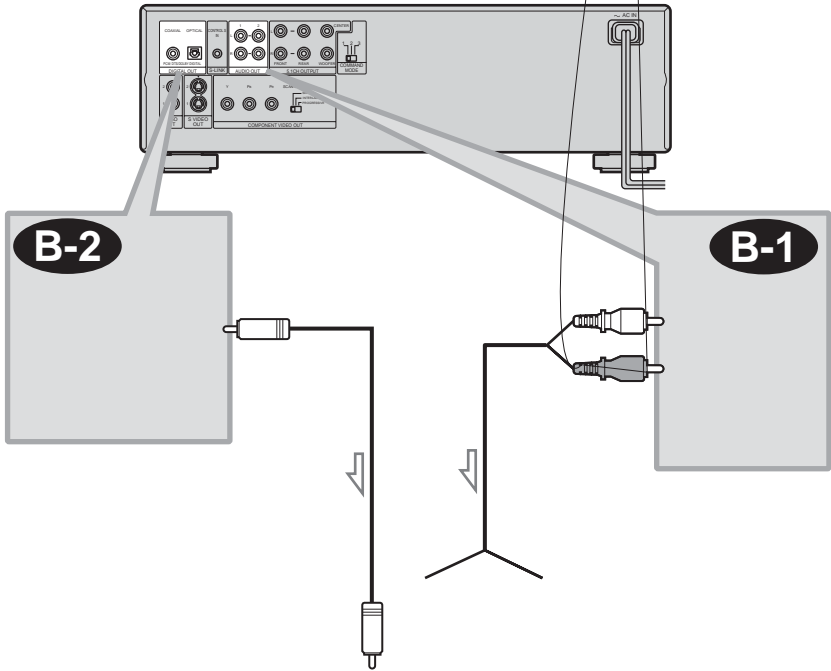

### **Hint**

To realize better surround sound effects, make sure that your listening position is in between your speakers.

### **Note**

Super Audio CD audio signals are not output from the digital jack.

## C Connecting to an AV amplifier (receiver) having a Dolby Surround (Pro Logic) decoder and 3 to 6 speakers

You can enjoy the Dolby Surround effects only when playing Dolby Surround audio or multi-channel audio (Dolby Digital) discs.

If your amplifier (receiver) has L and R audio input jacks only, use **C-1**. If your amplifier (receiver) has a digital input jack, use **C-2**.

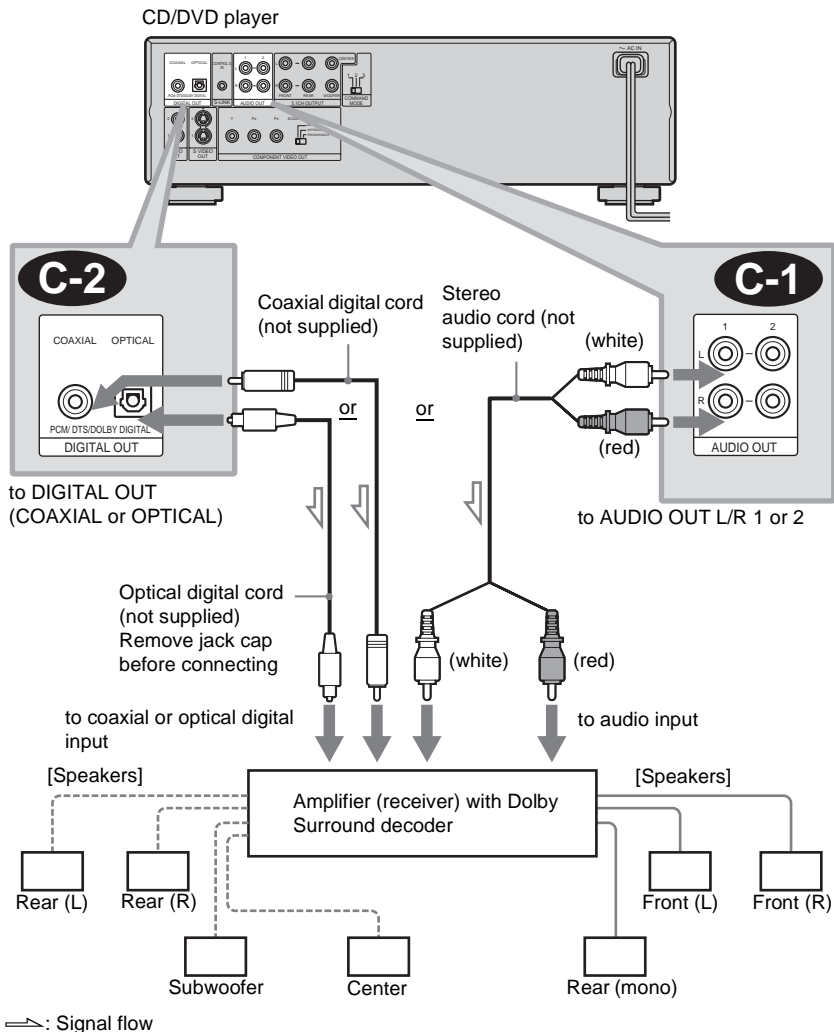

### Hint

For correct speaker location, refer to the operating instructions of the amplifier (receiver).

### Notes

- When connecting 6 speakers, replace the monaural rear speaker with a center speaker, 2 rear speakers and a subwoofer.
- Super Audio CD audio signals are not output from the digital jack.



## D Connecting to an AV amplifier (receiver) with 5.1 ch input jacks and/or a digital input jack and 4 to 6 speakers

If your AV amplifier (receiver) has 5.1 channel inputs, use **D-1**.

If you want to use the Dolby Digital or DTS decoder function on your AV amplifier (receiver), connect to its digital jack using **D-2**. With the following connections, you can enjoy a more realistic audio presence in the comfort of your own home.

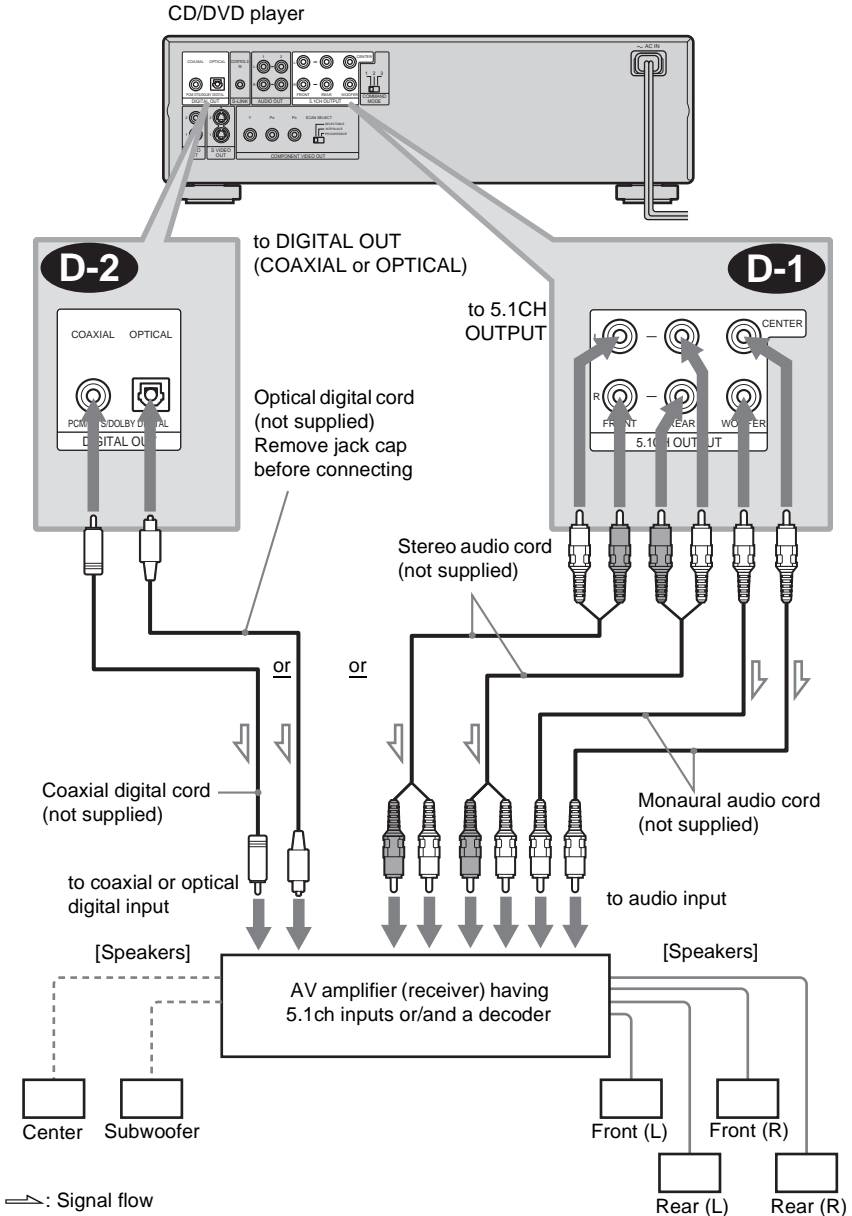

### **D-1** : Connecting to the 5.1ch input jacks

You can enjoy 5.1ch surround sound using the internal Dolby Digital, DTS, or Super Audio CD Multi decoder of this player.

### **D-2** : Connecting to a digital jack

This connection will allow you to use the Dolby Digital or DTS decoder function of your AV amplifier (receiver). You are not able to enjoy the surround sound effects of this player.

#### Hints

- For correct speaker placement, refer to the instructions of the connected components.
- To enhance the sound performance:
  - Use high-performance speakers.
  - Use front, rear, and center speakers of the same size and performance.
  - Place the subwoofer between the left and right front speakers.
- Use connection **D-2** when connecting to 7 or more speakers (6.1 ch or more).

#### **Notes**

##### **For connection **D-2****

- After you have completed the connection, be sure to set “DOLBY DIGITAL” to “DOLBY DIGITAL” and “DTS” to “DTS” in Quick Setup (page 27).
- When you connect an amplifier (receiver) that conforms to the 96kHz sampling frequency, set “48kHz/96kHz PCM” in “AUDIO SETUP” to “96kHz/24bit” (page 76).
- Super Audio CD audio signals are not output from the digital jack.

## Step 5: Connecting the Power Cord

Plug the player and TV power cords into an AC outlet.

## Step 6: Quick Setup

Follow the steps below to make the minimum number of basic adjustments for using the player. To skip an adjustment, press ►►. To return to the previous adjustment, press ◀◀.

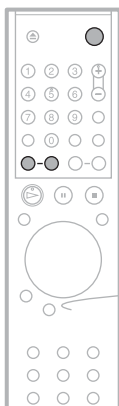

**1** Turn on the TV.

**2** Press **II**.

**3** Switch the input selector on your TV so that the signal from the player appears on the TV screen.

“Press [ENTER] to run QUICK SETUP” appears at the bottom of the screen. If this message does not appear, select “QUICK” under “SETUP” in the Control Menu to run Quick Setup (page 70).

**4** Press **ENTER** without inserting a disc.

The Setup Display for selecting the language used in the on-screen display appears.

**5** Press **↑/↓** to select a language.

The player uses the language selected here to display the menu and subtitles as well.



**B-2** **C-2**

- D-PCM (page 75)

**D-2**

- DOLBY DIGITAL (only if the amplifier (receiver) has a Dolby Digital decoder) (page 75)

### 13 Press ENTER.

“DTS” is selected.

AUDIO SETUP	
AUDIO ATT:	OFF
AUDIO DRC:	STANDARD
AUDIO FILTER:	SHARP
DOWNMIX:	DOLBY SURROUND
DIGITAL OUT:	ON
DOLBY DIGITAL:	D-PCM
DTS:	D-PCM
48kHz/96kHz PCM:	D-PCM
	DTS

### 14 Press $\uparrow/\downarrow$ to select the type of DTS signal sent to your amplifier (receiver).

Choose the item that matches the audio connection you selected on pages 23 to 25 (**B** through **D**).

**B-2** **C-2**

- D-PCM (page 75)

**D-2**

- DTS (only if the amplifier (receiver) has a DTS decoder) (page 75)

### 15 Press ENTER.

◆ When “DIGITAL OUTPUT” is selected in step 11

- Quick Setup is finished and connections are complete.

◆ When “DIGITAL & 5.1CH OUTPUT” is selected in step 11

- The Setup Display for “SPEAKER SETUP” appears.

### 16 Press $\uparrow/\downarrow$ to select the size of the center speaker.

If no center speaker is connected, select “NONE” (page 77).

SPEAKER SETUP (DVD)	
SIZE:	
DISTANCE:	
LEVEL(FRONT):	
LEVEL(REAR):	
TEST TONE:	OFF
FRONT:	
CENTER:	

### 17 Press ENTER.

“REAR” is selected.

### 18 Press $\uparrow/\downarrow$ to select the size of the rear speakers.

If no rear speaker is connected, select “NONE.”

### 19 Press ENTER.

“SUBWOOFER” is selected.

### 20 Press $\uparrow/\downarrow$ to select whether or not you have connected a subwoofer.

### 21 Press ENTER.

Quick Setup is finished. All connections and setup operations are complete.

---

## Enjoying the surround sound effects

To enjoy the surround sound effects of this player or your amplifier (receiver), set the following items as described below for the audio connection you selected on pages 23 to 25 ( **B** through **D** ). Each of these is the default setting and does not need to be adjusted when you first connect the player. Refer to page 69 for using the Setup Display.

### Audio Connection (pages 22 to 25)

- A**
  - No additional settings are needed.
- B-1 C-1**
  - Set “DOWNMIX” to “DOLBY SURROUND” (page 75).
- B-2 C-2 D-2**
  - Set “DOWNMIX” to “DOLBY SURROUND” (page 75).
  - Set “DIGITAL OUT” to “ON” (page 75).
- D-1**
  - Set “DISTANCE,” “LEVEL (FRONT),” and “LEVEL (REAR)” according to the connected speakers (page 77).

### Hints

- For connections B-1 C-1 D-1**

If the sound distorts even when the volume is turned down, set “AUDIO ATT” to “ON” (page 74).
- For connections B-2 C-2 D-2**

Set “48kHz/96kHz PCM” to “96kHz/24bit” only if you connect an amplifier (receiver) that conforms to the 96 kHz sampling frequency (page 76).
- The speaker size you set in steps 16 through 20 will also adjust the Super Audio CD speaker size of “SPEAKER SETUP.” If you want to change the speaker size for Super Audio CDs, you can set it in “SPEAKER SETUP” (page 76).

## Playing Discs **DVD-V**

**DVD-RW** **VCD** **SA-CD** **CD**

**DATA CD**

Depending on the DVD or VIDEO CD, some operations may be different or restricted. Refer to the operating instructions supplied with your disc.

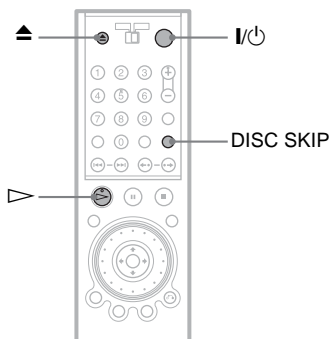
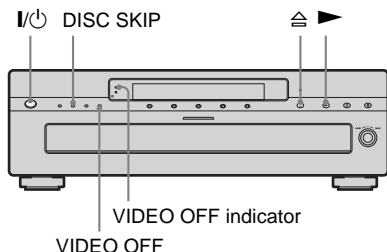

- 1 Turn on your TV.
- 2 Press **I/O**.  
The player turns on.
- 3 Switch the input selector on your TV so that the signal from the player appears on the TV screen.

### ◆ When using an amplifier (receiver)

Turn on the amplifier (receiver) and select the appropriate channel so that you can hear sound from the player.

- 4 Press **△** on the player, and place a disc on the disc tray.

To place other discs on the tray, press **DISC SKIP** and place the discs in the order you want to play them.

Each time you press **DISC SKIP**, the disc tray turns so you can place the discs on the empty compartments. The player plays from the last disc placed on the tray.

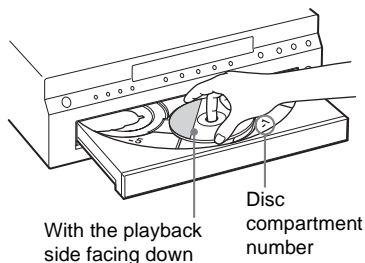

- 5 Press **▷**.

The disc tray closes, and the player starts playback (continuous play). Adjust the volume on the TV or the amplifier (receiver).

Depending on the disc, a menu may appear on the TV screen. For DVD VIDEOS, see page 35. For VIDEO CDs, see page 37.

### To enjoy the clarity of Super Audio CD/CD sound more

You can minimize the effect of the video output by switching it off.

Press **VIDEO OFF** on the player so that the **VIDEO OFF** indicator lights up on the player.

### To turn off the player

Press **I/O**. The player enters standby mode.

### 🔔 Hint

You can have the player turn off automatically whenever you leave it in stop mode for more than 30 minutes. To turn on this function, set "AUTO POWER OFF" in "CUSTOM SETUP" to "ON" (page 73).

## Note

Super Audio CD audio signals are not output from the digital jack.

## Additional operations

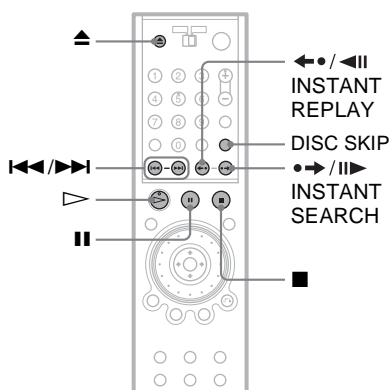
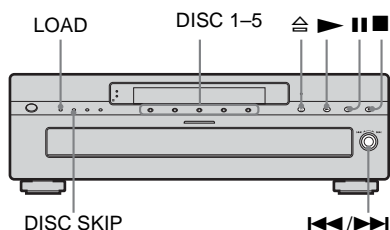

To	Operation
Select a disc	Press DISC 1-5 on the player.
Stop	Press ■.
Pause	Press ■■.
Resume play after pause	Press ■■ or ▷.
Go to the next disc	Press DISC SKIP.
Go to the next chapter, track, or scene in continuous play mode	Press ►► on the remote, or turn the ◀◀/►► dial on the player clockwise.
Go back to the previous chapter, track, or scene in continuous play mode	Press ◀◀ on the remote, or turn the ◀◀/►► dial on the player counterclockwise.
Stop play and remove the disc	Press ▲.

To	Operation
Replay the previous scene*	Press ◀◀/◀◀ INSTANT REPLAY during playback.
Briefly fast forward the current scene**	Press ►►/►► INSTANT SEARCH during playback.
Check if a disc is in the disc compartment	Press LOAD on the player. The disc number indicators on the front panel display (1-5) light up.

\* For DVD VIDEOS and DVD-RWs/DVD-Rs only.

\*\* For DVD VIDEOS and DVD-RWs/DVD-Rs or DVD+RWs only.

## Hints

- The Instant Replay function is useful when you want to review a scene or dialog that you missed.
- The Instant Search function is useful when you want to pass over a scene that you don't want to watch.
- Before loading the discs, a disc number indicator of an empty compartment may be lit.

## Note

You may not be able to use the Instant Replay function with some scenes.



## Replacing discs while playing a disc (EXCHANGE)

You can open the disc tray while playing a disc so that you can check which discs are to be played next and replace discs without interrupting playback of the current disc.

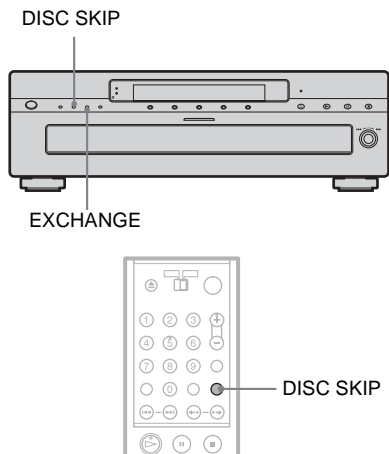

- 1 Press EXCHANGE.**  
The disc tray opens and two disc compartments appear. Even if the player is playing a disc, it doesn't stop playing.
- 2 Replace the discs in the compartments with new ones.**
- 3 Press DISC SKIP.**  
The disc tray turns and another two disc compartments appear.
- 4 Replace the discs in the compartments with new ones.**
- 5 Press EXCHANGE.**  
The disc tray closes.

### Hint

- While the disc tray is open,
- If the playback of the current disc ends, the player stops playing. If the disc is played in One Disc Repeat Play mode (page 44), the current disc starts playing again.
  - In All Discs Shuffle Play mode (page 43), titles/tracks/chapters are reshuffled only on the current disc.
  - In Program Play mode (page 41), the titles/tracks/chapters only on the current disc are played.



### Note

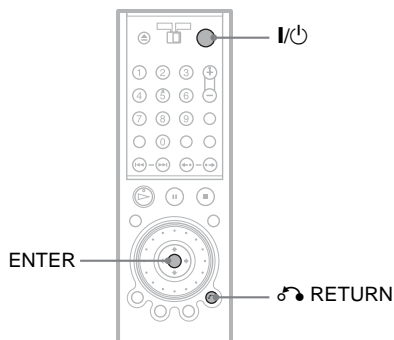

Do not push the disc tray to close in step 5, as you may damage the player.

## Locking the disc tray (Child Lock)



You can lock the disc tray to prevent children from opening it.



When the player is in standby mode, press  RETURN, ENTER, and then  I/O on the remote.

The player turns on and "LOCKED" appears on the front panel display. The  and EXCHANGE buttons on the player and the  button on the remote do not work while the Child Lock is set.

### To unlock the disc tray

When the player is in standby mode, press  RETURN, ENTER, and then  I/O again.

### Note

Even if you select "RESET" under "SETUP" in the Control Menu (page 70), the disc tray remains locked.

# Resuming Playback From the Point Where You Stopped the Disc (Multi-disc Resume)

Resume) **DVD-V** **VCD**

The player stores the point where you stopped the disc for up to 40 discs and resumes playback the next time you insert the same disc. The player remembers the stopped point of the disc even after you play other discs in the disc tray. When you store a resume playback point for the 41th disc, the resume playback point for the first disc is deleted.

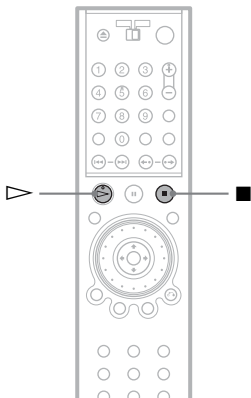

## 1 While playing a disc, press ■ to stop playback.

“RESUME” appears on the front panel display.

## 2 Press ▷.

The player starts playback from the point where you stopped the disc in step 1.

### Hints

- To play from the beginning of the disc, press ■ twice, then press ▷.
- For DVD-RWs in VR mode, CDs, Super Audio CDs, and DATA CDs, the player remembers the resume playback point for the current disc. The point where you stopped is cleared when:
  - you press DISC SKIP or DISC SELECT.
  - you opened the disc tray.
  - you disconnect the power cord.

– the player enters standby mode (DATA CD only).

- To turn off the Multi-disc Resume function, set “MULTI-DISC RESUME” in “CUSTOM SETUP” to “OFF” (page 74). Playback restarts at the resume point only for the current disc in the player.

### Notes

- “MULTI-DISC RESUME” in “CUSTOM SETUP” must be set to “ON” (default) for this function to work (page 74).
- The resume playback point for the current disc is cleared when:
  - you change the play mode.
  - you change the settings on the Setup Display.
- Resume Play does not work during Shuffle Play and Program Play.
- This function may not work with some discs.
- If “MULTI-DISC RESUME” in “CUSTOM SETUP” is set to “ON” and you playback a recorded disc such as DVD-RW, the player may playback other recorded discs from the same resume point. To play from the beginning, press ■ twice and then press ▷.

## Using the DVD's Menu

### DVD-V

A DVD is divided into long sections of a picture or a music feature called "titles." When you play a DVD which contains several titles, you can select the title you want using the TOP MENU button. When you play DVDs that allow you to select items such as the language for the subtitles and the language for the sound, select these items using the MENU button.

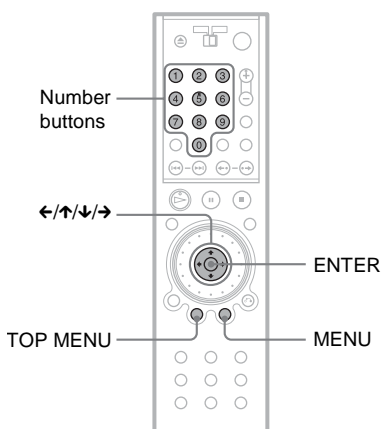

- 1 Press TOP MENU or MENU.**

The disc's menu appears on the TV screen.  
The contents of the menu vary from disc to disc.
- 2 Press ←/↑/↓/→ or the number buttons to select the item you want to play or change.**

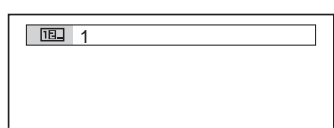

- 3 Press ENTER.**

## Selecting "ORIGINAL" or "PLAY LIST" on a DVD-RW Disc

### DVD-RW

Some DVD-RW discs in VR (Video Recording) mode have two types of titles for playback: originally recorded titles (ORIGINAL) and titles that can be created on recordable DVD players for editing (PLAY LIST). You can select the type of titles to be played.

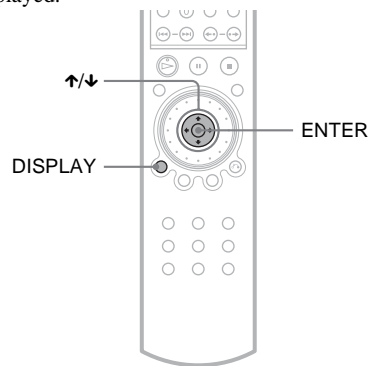

- 1 Press DISPLAY in stop mode.**

The Control Menu appears.
- 2 Press ↑/↓ to select  (ORIGINAL/PLAY LIST), then press ENTER.**

The options for "ORIGINAL/PLAY LIST" appear.

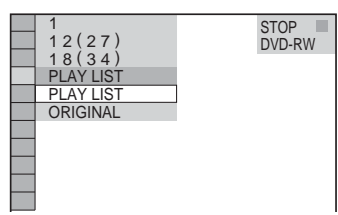

### 3 Press $\uparrow/\downarrow$ to select the setting.

- **PLAY LIST**: plays the titles created from “ORIGINAL” for editing.
- **ORIGINAL**: plays the titles originally recorded.

### 4 Press ENTER.

#### To turn off the Control Menu

Press DISPLAY repeatedly until the Control Menu is turned off.

---

## Selecting a Playback Area for a Super Audio CD Disc **SACD**

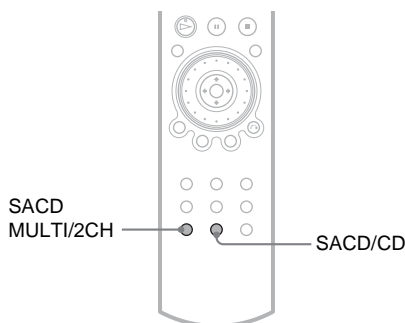

---

## Selecting a playback area on a 2 channel + Multi-channel Super Audio CD

Some Super Audio CDs consist of a 2 channel playback area and a multi-channel playback area. You can select the playback area you want to listen to.

- 1 Press **SACD MULTI/2CH** in stop mode. The following display appears.

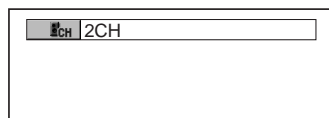

- 2 Press **SACD MULTI/2CH** repeatedly to select the item.
  - **MULTI**: plays a multi-channel playback area.
  - **2CH**: plays a 2 channel playback area. The **MULTI CHANNEL** indicator lights up on the player when playing a multi-channel playback area.

---

#### **Hint**

You can also select “MULTI/2CH” from the Control Menu (page 13).

## Selecting a playback layer when playing a hybrid Super Audio CD

Some Super Audio CDs consist of an HD layer and a CD layer. You can select the playback layer you want to listen to.

### Press SACD/CD in stop mode.

Each time you press the button, an HD layer or a CD layer is alternately selected. When playing a CD layer, the “CD” indicator in the front panel display lights up.

### Notes

- For details about Super Audio CD discs, see page 84.
- Each play mode function works only within the selected layer or playback area (page 41).

## Playing VIDEO CDs With PBC Functions (PBC Playback)

### VCD

PBC (Playback Control) allows you to play VIDEO CDs interactively by following the menu on the TV screen.

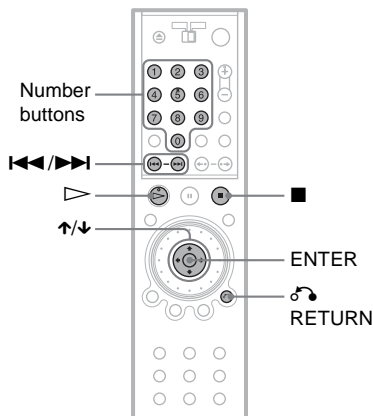

### 1 Start playing a VIDEO CD with PBC functions.

The menu for your selection appears.

### 2 Select the item number and track you want using $\uparrow/\downarrow$ or the number buttons.

### 3 Press ENTER.

### 4 Follow the instructions in the menu for interactive operations.

Refer to the instructions supplied with the disc, as the operating procedure may differ depending on the VIDEO CD.

### To return to the menu

Press  $\curvearrowright$  RETURN.

### Hint

To play without using PBC, press **◀▶** or the number buttons on the remote (or turn the **◀▶**/**▶▶** dial on the player) while the player is stopped to select a track, then press **▷** or ENTER.

“Play without PBC” appears on the TV screen and the player starts continuous play. You cannot play still pictures such as a menu.

To return to PBC playback, press **■** twice then press **▷**.

### Notes

- Depending on the VIDEO CD, “Press ENTER” in step 3 may appear as “Press SELECT” in the instructions supplied with the disc. In this case, press **▷**.
- The PBC functions of Super VCDs do not work with this player. Super VCDs are played in continuous play mode only.

## Playing an MP3 Audio Track **DATA CD**

You can play DATA CDs (CD-ROMs/CD-Rs/CD-RWs) recorded in MP3 (MPEG1 Audio Layer 3) format.

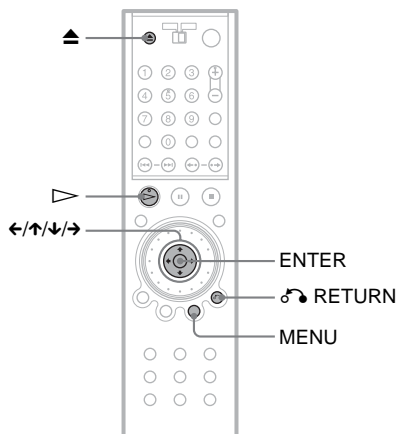

**1** Press **▲** and place a DATA CD on the disc tray.

**2** Press **▷**.

The disc tray closes, and the player starts to play the first MP3 audio track in the first album on the disc.

### Notes

- The player can play MP3 audio tracks recorded in the following sampling frequencies: 32 kHz, 44.1 kHz, 48 kHz.
- The playback order may be different from the edited order. See “The playback order of MP3 audio tracks” (page 40) for details.

## Selecting an album and track

### 1 Press MENU.

The list of MP3 albums recorded on the DATA CD appears.

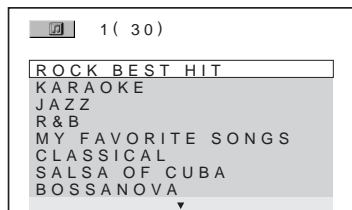

### 2 Select an album using ↑/↓ and press ENTER.

The list of tracks contained in the album appears.

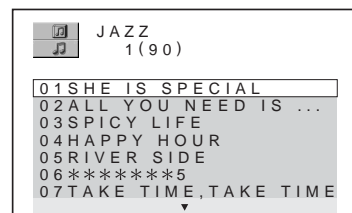

### 3 Select a track using ↑/↓ and press ENTER.

The selected track starts playing.

When a track or album is being played, its title is shaded.

## About MP3 audio tracks

You can play MP3 audio tracks on CD-ROMs or CD-Rs/CD-RWs. However, the discs must be recorded according to ISO9660 level 1, level 2, or Joliet format for the player to recognize the tracks.

You can also play discs recorded in Multi Session.

See the instructions of the CD-R/CD-RW device or recording software (not supplied) for details on the recording format.

### To play a Multi Session CD

This player can play Multi Session CDs when an MP3 audio track is located in the first session. Any subsequent MP3 audio tracks, recorded in the later sessions, can also be played back.

When audio tracks and images in music CD format or video CD format are recorded in the first session, only the first session will be played back.

### Notes

- If you put the extension “.MP3” to data not in MP3 format, the player cannot recognize the data properly and will generate a loud noise which could damage your speaker system.
- The player cannot play audio tracks in MP3PRO format.

### To go to the next or previous page

Press → or ←.

### To return to the previous display

Press ⏪ RETURN.

### To turn off the display

Press MENU.

### Notes

- Only the letters in the alphabet and numbers can be used for album or track names. Anything else is displayed as “\*.”
- ID3 tags cannot be displayed.

## The playback order of MP3 audio tracks

The playback order of albums and tracks recorded on a DATA CD is as follows.

### ◆ Structure of disc contents

Tree 1    Tree 2    Tree 3    Tree 4    Tree 5

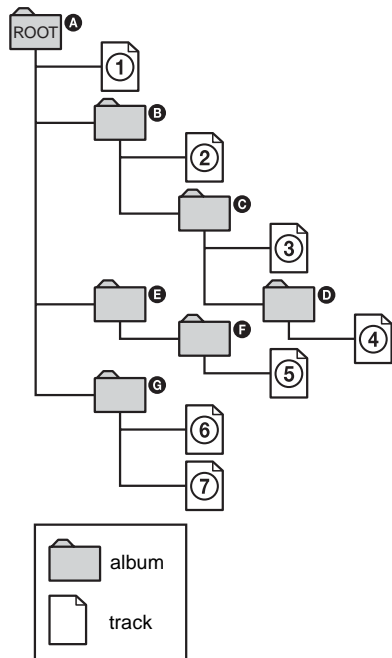

When you insert a DATA CD and press  $\triangleright$ , the numbered tracks are played sequentially, from ① through ⑦. Any sub-albums/tracks contained within a currently selected album take priority over the next album in the same tree. (Example: C contains D so ④ is played before ⑤.)

When you press MENU and the list of MP3 albums appears (page 39), the albums are arranged in the following order: A → B → C → D → F → G. Albums that do not contain tracks (such as album E) do not appear in the list.

### 💡 Hints

- If you add numbers (01, 02, 03, etc.) to the front of the track names, the tracks will be played in that order.
- Since a disc with many trees takes longer to start playback, it is recommended that you create the albums of no more than two trees.

### Notes

- Depending on the software you use to create the DATA CD, the playback order may differ from the illustration above.
- The playback order above may not be applicable if there are more than a total of 999 albums and tracks in the DATA CD.
- The player can recognize up to 499 albums (the player will count just albums, including albums that do not contain MP3 audio tracks). The player will not play any albums beyond the first 499 albums. Of the first 499 albums, the player will play no more than a combined total of 999 albums and tracks.



## Various Play Mode Functions (Program Play, Shuffle Play, Repeat Play, A-B Repeat Play)

You can set the following play modes:

- Program Play (page 41)
- Shuffle Play (page 43)
- Repeat Play (page 44)
- A-B Repeat Play (page 45)

### Notes

- The play mode is canceled when:
  - you open the disc tray.
  - the player enters standby mode by pressing I/⏻.
- Before setting a play mode for Super Audio CDs, select the playback layer or area you want to listen to (page 36). Each play mode function works only within the selected layer or playback area.

## Selecting the disc mode (One Disc or All Discs)

**DVD-V DVD-RW VCD SA-CD CD DATA CD**

You can play one disc or all of the discs in the player. Before setting Program Play, Shuffle Play, or Repeat Play, you must select whether to set those play mode on one disc or all of the discs.

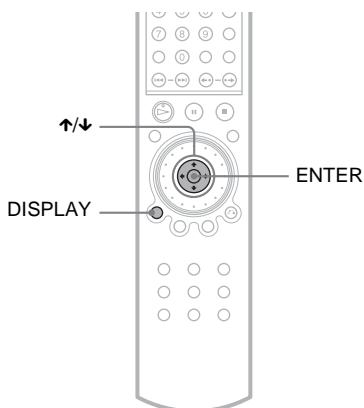

- 1 Press DISPLAY once or twice. The Control Menu appears.

- 2 Press ↑/↓ to select or (ALL DISCS/ONE DISC) and press ENTER. The options for “ALL DISCS/ONE DISC” appear.

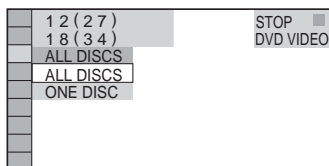

- 3 Press ↑/↓ to select the item.
  - ALL DISCS: continuously plays all discs.
  - ONE DISC: plays the selected disc.
- 4 Press ENTER.

## Creating your own program (Program Play) **DVD-V VCD SA-CD CD**

You can play the contents of a disc in the order you want by arranging the order of the titles, chapters, or tracks on the disc to create your own program.

You can program up to 99 items. By selecting All Discs mode (page 41), you can create a program for all of the discs in the player.

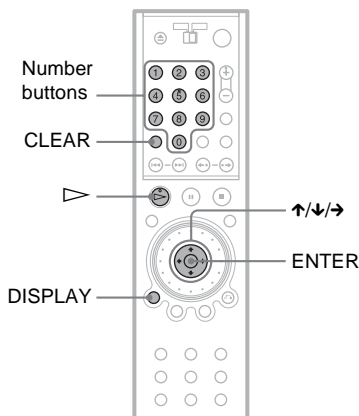

- 1 Press DISPLAY twice. The Control Menu appears.
- 2 Press ↑/↓ to select (PROGRAM), then press ENTER. The options for “PROGRAM” appear.

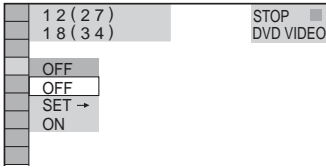

- 3** Press  $\uparrow/\downarrow$  to select “SET →,” then press ENTER.

The display for programming appears.

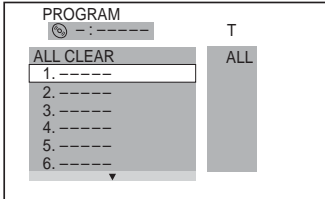

- 4** Press  $\rightarrow$ .

The player is ready to program the first disc.

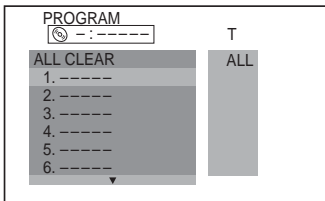

- 5** Select the disc you want to program using the number buttons or  $\uparrow/\downarrow$ , then press ENTER.

The cursor moves to the title or track row “T” (in this case, “01”).

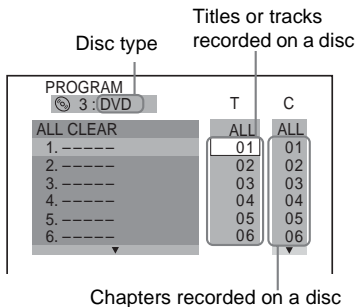

“?” appears when the player has not played the disc.

- 6** Select the title, chapter, or track you want to program.

◆ When playing a DVD VIDEO

For example, select chapter “03” of title “02.”

Press  $\uparrow/\downarrow$  or the number buttons to select “02” under “T,” then press ENTER.

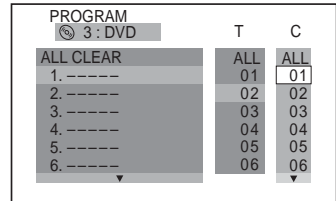

Next, press  $\uparrow/\downarrow$  or the number buttons to select “03” under “C,” then press ENTER.

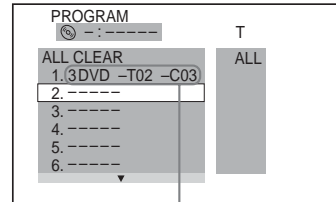

Selected disc, title, and chapter

◆ When playing a VIDEO CD, Super Audio CD, or CD

For example, select track “02.”

Press  $\uparrow/\downarrow$  or the number buttons to select “02” under “T,” then press ENTER.

The track number may be displayed in 3 digits for a Super Audio CD.

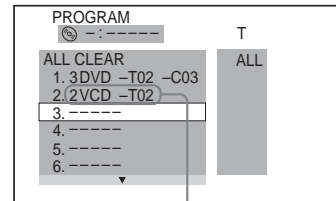

Selected disc and track

- 7** To program other discs, titles, chapters, or tracks, repeat steps 4 to 6.

The programmed discs, titles, chapters, and tracks are displayed in the selected order.

## 8 Press $\triangleright$ to start Program Play.

Program Play begins.

When the program ends, you can restart the same program again by pressing  $\triangleright$ .

### To return to normal play

Press CLEAR, or select “OFF” in step 3.

### To turn off the display

Press DISPLAY repeatedly until the display is turned off.

### To change or cancel a program

- 1 Follow steps 1 through 3 of “Creating your own program (Program Play).”
- 2 Select the program number of the disc, title, chapter, or track you want to cancel or change using  $\uparrow/\downarrow$ .
- 3 To cancel the program, press CLEAR. To change the program, follow steps 4 through 6 for new programming.

### To cancel all the discs, titles, chapters, or tracks in the programmed order

- 1 Follow steps 1 through 3 of “Creating your own program (Program Play).”
- 2 Press  $\uparrow$  and select “ALL CLEAR.”
- 3 Press ENTER.

#### Hint

You can do Repeat Play or Shuffle Play of the programmed titles, chapters, or tracks. During Program Play, follow the steps of “Repeat Play” (page 44) or “Shuffle Play” (page 43).

#### Notes

- You cannot use this function with VIDEO CDs with PBC playback.
- When playing Super VCDs, the total time of the programmed tracks does not appear on the screen.

## Playing in random order (Shuffle Play)

**DVD-V DVD-RW VCD SA-CD CD**

### DATA CD

You can have the player “shuffle” titles, chapters, or tracks. Subsequent “shuffling” may produce a different playing order. By selecting All Discs mode (page 41), you can shuffle all of the discs in the player.

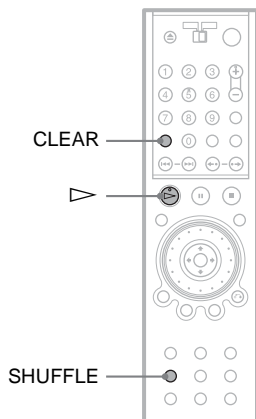

## 1 Press SHUFFLE during playback.

The following display appears.

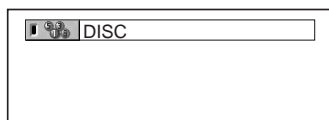

## 2 Press SHUFFLE repeatedly to select the item to be shuffled.

### ◆ When playing a DVD VIDEO

- DISC\*
- TITLE
- CHAPTER

### ◆ When playing a VIDEO CD, Super Audio CD, or CD

- DISC\*
- TRACK

### ◆ When playing a DVD-RW or DATA CD

- DISC\*

### ◆ When Program Play is activated

- ON: shuffles titles, chapters, or tracks selected in Program Play.

\* You can select “DISC” in All Discs mode only.

## To return to normal play

Press CLEAR, or select "OFF" in step 2.

### Hints

- You can set Shuffle Play while the player is stopped. After selecting the "SHUFFLE" option, press . Shuffle Play starts.
- Up to 96 chapters in a disc can be played in random order when "CHAPTER" is selected.
- You can also select "SHUFFLE" from the Control Menu (page 13).

### Note

You cannot use this function with VIDEO CDs with PBC playback.

## Playing repeatedly (Repeat Play)

**DVD-V** **DVD-RW** **VCD** **SA-CD** **CD** **DATA CD**

You can play all of the titles, albums, or tracks on a disc or a single title, chapter, album, or track repeatedly.

You can use a combination of Shuffle or Program Play modes. By selecting All Discs mode (page 41), you can repeat all of the discs in the player.

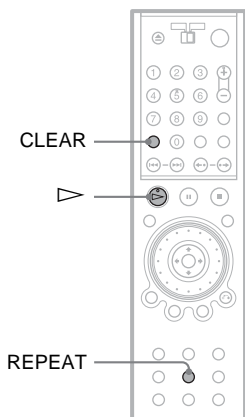

## 1 Press REPEAT during playback.

The following display appears.

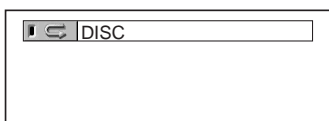

## 2 Press REPEAT repeatedly to select the item to be repeated.

### ◆ When playing a DVD VIDEO

- DISC: repeats all of the titles on the current disc in One Disc mode, or all of the discs in All Discs mode.
- TITLE: repeats the current title on a disc.
- CHAPTER: repeats the current chapter.

### ◆ When playing a DVD-RW

- DISC: repeats all of the titles on the selected type in One Disc mode, or all of the discs in All Discs mode.
- TITLE: repeats the current title on a disc.
- CHAPTER: repeats the current chapter.

### ◆ When playing a VIDEO CD, Super Audio CD, or CD

- DISC: repeats all of the tracks on the current disc in One Disc mode, or all of the discs in All Discs mode.
- TRACK: repeats the current track.

### ◆ When playing a DATA CD (MP3 audio)

- DISC: repeats all of the albums on the current disc in One Disc mode, or all of the discs in All Discs mode.
- ALBUM: repeats the current album.
- TRACK: repeats the current track.

### ◆ When Program Play or Shuffle Play is activated

- ON: repeats Program Play or Shuffle Play.

## To return to normal play

Press CLEAR, or select "OFF" in step 2.

### Hints

- You can set Repeat Play while the player is stopped. After selecting the "REPEAT" option, press . Repeat Play starts.
- You can also select "REPEAT" from the Control Menu (page 13).

### Note

You cannot use this function with VIDEO CDs with PBC playback.

## Repeating a specific portion (A-B Repeat Play) **DVD-V** **DVD-RW** **VCD**

**SA-CD** **CD**

You can play a specific portion of a title, chapter or track repeatedly. (This function is useful when you want to memorize lyrics, etc.)

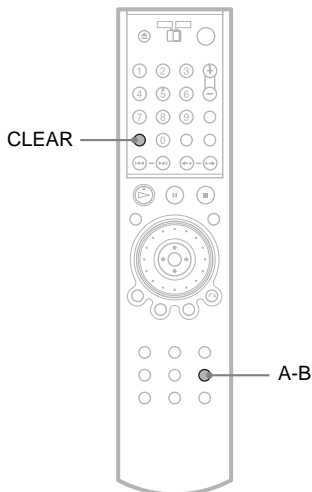

- 1** During playback, when you find the starting point (point A) of the portion to be played repeatedly, press A-B.

The starting point (point A) is set.

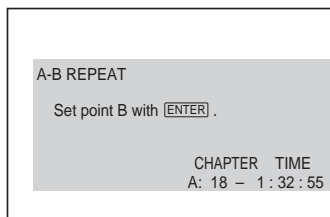

- 2** When you reach the ending point (point B), press A-B again.

The set points are displayed and the player starts repeating this specific portion.

### To return to normal play

Press CLEAR.

### Hint

You can also select "A-B REPEAT" from the Control Menu (page 13).

### Notes

- When you set A-B Repeat Play, the settings for Shuffle Play, Repeat Play, and Program Play are canceled.
- A-B Repeat Play does not work for titles containing still pictures on a DVD-RW in VR mode.
- A-B Repeat Play does not work across multiple titles ("ORIGINAL" or "PLAY LIST") on a DVD-RW in VR mode.

## Searching for a Scene

# Searching for a Particular Point on a Disc (Shuttle mode, Jog mode, Freeze Frame)

You can quickly locate a particular point on a disc by monitoring the picture or playing back slowly.

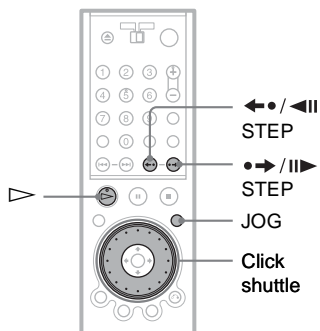

### Note

Depending on the DVD/VIDEO CD, you may not be able to do some of the operations described.

## Using the click shuttle on the remote (Shuttle mode)

DVD-V DVD-RW VCD SA-CD CD DATA CD

Turn the click shuttle on the remote. The playback speed changes depending on the turning direction and degree of rotation shown below. Actual speeds may differ with some discs.

### ◆During playback

FF3▶▶▶ Fast forward (DVD VIDEO/ DVD-RW/VIDEO CD only)

FF2▶▶▶ Fast forward

FF1▶▶▶ Fast forward

×2▶ (DVD VIDEO/Super Audio CD/CD only)

PLAY▶▶▶ (normal speed)

×2◀ (DVD VIDEO only)

FR1◀◀◀ Fast reverse

FR2◀◀◀ Fast reverse

FR3◀◀◀ Fast reverse (DVD VIDEO/ DVD-RW/VIDEO CD only)

The “×2▶”/“×2◀” playback speed is about twice the normal speed. The “FF3▶▶▶”/“FR3◀◀◀” playback speed is faster than the “FF2▶▶▶”/“FR2◀◀◀” and the “FF2▶▶▶”/“FR2◀◀◀” playback speed is faster than FF1▶▶▶”/FR1◀◀◀.”

If you turn the click shuttle quickly, the playback speed goes to “FF3▶▶▶” or “FR3◀◀◀” immediately.

### ◆During pause mode (DVD VIDEO, DVD-RW, VIDEO CD only)

SLOW1▶▶▶ (playback direction)

SLOW2▶▶▶ (playback direction)

PAUSE◻◻

SLOW2◀◀◀ (opposite direction) (DVD only)

SLOW1◀◀◀ (opposite direction) (DVD only)

The “SLOW2 ▶▶▶”/“SLOW2 ◀◀◀” playback speed is slower than “SLOW1 ▶▶▶”/“SLOW1 ◀◀◀.”

### To return to normal play

Press ▷.

## Playing a disc frame by frame using the click shuttle

(See mode)

speed, frame-by-frame so that the click shuttle is used, and go backwards (DVD) using the click shuttle at a speed of 1/4 or normal.

### Normal play

#### Jog mode

Press **JOG** so that the JOG button turns off.

## Playing a disc frame by frame (Freeze)

When the disc is in the pause mode, press **STOP** to the next frame. Press **STOP** to go to the preceding frame. Press **STOP** and hold the button down, you can freeze the disc frame in succession. To return to normal playback, press **STOP**.

## Searching for a Title/Chapter/Track/Scene, etc.

You can search a DVD by title or chapter, and you can search a VIDEO CD/Super Audio CD/CD by track, index, or scene. As titles and DATA CD tracks are assigned unique numbers on the disc, you can select the desired one by entering its number. Or, you can search for a scene using the time code.

### 1 Press DISPLAY.

The Control Menu appears.

### 2 Press **↑/↓** to select the search method.

- ◆ When playing a DVD VIDEO/DVD-RW DISC

#### TIME/TEXT

Select "TIME/TEXT" to search for a starting point by inputting the time code.

- ◆ When playing a VIDEO CD without PBC Playback

DISC  
TRACK  
INDEX

- ◆ When playing a VIDEO CD with PBC Playback



- ◆ When playing a Super Audio CD/CD



- ◆ When playing a DATA CD (MP3 audio)



Example: when you select  CHAPTER

“\*\* (\*\*)” is selected (\*\* refers to a number). The number in parentheses indicates the total number of titles, chapters, tracks, indexes or scenes.

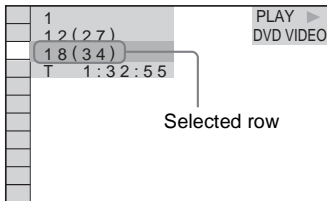

### 3 Press ENTER.

“\*\* (\*\*)” changes to “-- (\*\*).”

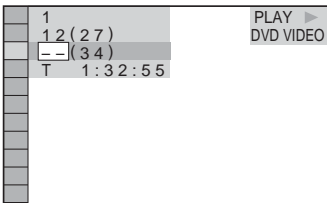

### 4 Press $\uparrow/\downarrow$ or the number buttons to select the title, chapter, track, index, or scene number you want to search.

If you make a mistake

Cancel the number by pressing CLEAR, then select another number.

## 5 Press ENTER.

The player starts playback from the selected number.

### To search for a scene using the time code (DVD VIDEO/DVD-RW only)

- 1 In step 2, select  TIME/TEXT. “T \*\*:\*\*:\*\*” (playing time of the current title) is selected.
- 2 Press ENTER. “T \*\*:\*\*:\*\*” changes to “T --:--:--.”
- 3 Input the time code using the number buttons, then press ENTER. For example, to find the scene at 2 hours, 10 minutes, and 20 seconds after the beginning, just enter “2:10:20.”

### Hints

- You can search for a chapter (DVD VIDEO/ DVD-RW) or track (CD/Super Audio CD/DATA CD) by pressing the number buttons and ENTER.
- You can display the first scene of titles, chapters or tracks recorded on the disc on a screen divided into 9 sections. You can start playback directly by selecting one of the scenes. For details, see “Searching by Scene (PICTURE NAVIGATION)” (page 49).

### Notes

- You cannot search for a scene on a DVD+RW using the time code.
- The title, chapter or track number displayed is the same number recorded on the disc.
- You cannot search for a still picture on a DVD-RW in VR mode.



# Searching by Scene

(PICTURE NAVIGATION) **DVD-V** **VCD**

You can divide the screen into 9 subscreens and find the desired scene quickly.

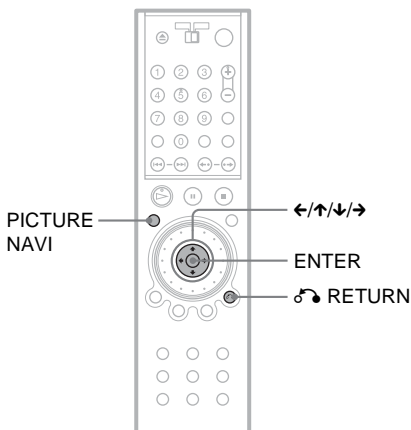

## 1 Press PICTURE NAVI during playback.

The following display appears.

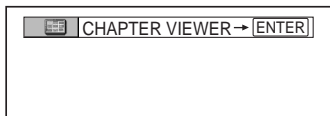

## 2 Press PICTURE NAVI repeatedly to select the item.

Refer to the explanations given for each item in the following sections.

- CHAPTER VIEWER (for DVD VIDEO only)
- TITLE VIEWER (for DVD VIDEO only)
- TRACK VIEWER (for VIDEO CD only)

## 3 Press ENTER.

To return to normal play

Press RETURN.

### Hint

You can also select "PICTURE NAVIGATION" from the Control Menu (page 13).

### Notes

- The "PICTURE NAVIGATION" is not available when playing Super VCDs.
- Depending on the disc, you may not be able to select all functions.
- The sound is muted when using this function.

## Scanning the chapter, title, or track (CHAPTER VIEWER, TITLE VIEWER, TRACK VIEWER)

You can divide the screen into 9 subscreens and display the first scene of chapters, titles, or tracks.

You can also play from the selected chapter, title, or track. After performing step 3 of "Searching by Scene (PICTURE NAVIGATION)" above, select the scene using and press ENTER.

### Hint

If there are more than 9 chapters, titles, or tracks, ▼ is displayed at the bottom right.

To display the additional chapters, titles, or tracks, select the bottom right scene (the position 9) and press . To return to the previous scene, select the top left scene (the position 1) and press .

1	2	3
4	5	6
7	8	9

▼

## Viewing Information About the Disc

# Checking the Playing Time and Remaining Time

**DVD-V DVD-RW VCD**  
**SA-CD CD DATA CD**

You can check the playing time and remaining time of the current title, chapter, or track. Also, you can check the DVD/Super Audio CD/CD text or track name (MP3 audio) recorded on the disc.

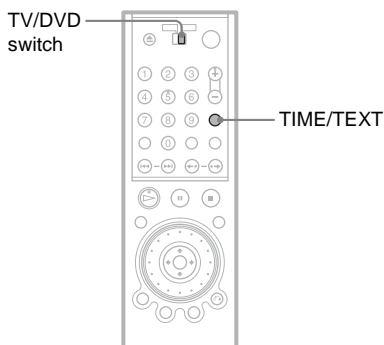

- 1 Slide the TV/DVD switch to DVD.
- 2 Press TIME/TEXT during playback.

The following display appears.

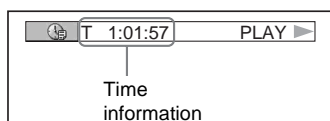

- 3 Press TIME/TEXT repeatedly to change the time information.

The display and the kinds of time that you can change depend on the disc you are playing.

### ◆ When playing a DVD VIDEO or DVD-RW

- T \*\*: \*\*: \* (hours : minutes : seconds)  
Playing time of the current title
- T- \*\*: \*\*: \*  
Remaining time of the current title
- C \*\*: \*\*: \*  
Playing time of the current chapter
- C- \*\*: \*\*: \*  
Remaining time of the current chapter

### ◆ When playing a VIDEO CD (with PBC functions)

- \*\*: \*\*: \* (minutes : seconds)  
Playing time of the current scene

### ◆ When playing a VIDEO CD (without PBC functions), Super Audio CD, or CD

- T \*\*: \*\*: \* (minutes : seconds)  
Playing time of the current track
- T- \*\*: \*\*: \*  
Remaining time of the current track
- D \*\*: \*\*: \*  
Playing time of the current disc
- D- \*\*: \*\*: \*  
Remaining time of the current disc

### ◆ When playing a DATA CD (MP3 audio)

- \*\*: \*\*: \* (minutes : seconds)  
Playing time of the current track

### ◆ When playing a Super VCD

- T \*\*: \*\*: \* (minutes : seconds)  
Playing time of the current track

### To check the DVD/Super Audio CD/CD text or track and album names (MP3 audio)

Press TIME/TEXT repeatedly in step 3 to display text recorded on the DVD/Super Audio CD/CD/DATA CD.

The DVD/Super Audio CD/CD text appears only when text is recorded in the disc. You cannot change the text. If the disc does not contain text, "NO TEXT" appears.

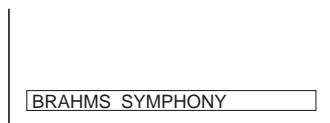

For DATA CDs, the track and album names of the MP3 audio track appears (page 53).

## Checking the information on the front panel display

You can view the time information and text displayed on the TV screen also on the front panel display. The information on the front panel display changes as follows when you change the time information on your TV screen.

### When playing a DVD VIDEO or DVD-RW

Title playing time and current disc, title and chapter number

DISC	TITLE	CHAP	HOUR	MIN	SEC
1.	1.	2	1:03	24	

Remaining time of the current title

DISC	TITLE	CHAP	HOUR	MIN	SEC
1.	1.	2	-1:15	36	

Playing time and number of the current chapter

DISC	CHAP	HOUR	MIN	SEC
1.	2	0:22	30	

Remaining time of the current chapter

DISC	CHAP	HOUR	MIN	SEC
1.	2	-0:13	20	

Text

SONY HITS/5					
-------------	--	--	--	--	--

### When playing a DATA CD (MP3 audio)

Track playing time and number of the current disc, album and track

DISC	ALBUM	TRACK	HOUR	MIN	SEC
4	SO	21	17	30	

Track name

01HAPPY BIRTH					
---------------	--	--	--	--	--

### When playing a VIDEO CD (without PBC functions), Super Audio CD, or CD

Track playing time and current disc, track and index number

DISC	TRACK	INDEX	MIN	SEC
1.	2	1	2	25

Remaining time of the current track

DISC	TRACK	INDEX	MIN	SEC
1.	2	1	-1	50

Playing time of the current disc

DISC	MIN	SEC
1.	32	12

Remaining time of the disc

DISC	MIN	SEC
1.	-20	18

Text

SONY HITS/5		
-------------	--	--

#### Hints

- When playing VIDEO CDs with PBC functions, the disc number, scene number and the playing time are displayed.
- Long text that does not fit in a single line will scroll across the front panel display.
- You can also check the time information and text using the Control Menu (page 13).

#### Notes

- Depending on the type of disc being played, the disc's text or track name may not be displayed.
- The player can only display the first level of the disc's text, such as the disc name or title.
- Playing time of MP3 audio tracks may not be displayed correctly.

## Checking the Play Information

You can check information such as the bit rate or the disc layer that is being played.

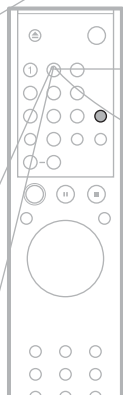

### To turn off the Control Menu

Press DISPLAY repeatedly until the Control Menu is turned off.

### Display of each item

By pressing DISPLAY repeatedly, you can display either "BIT RATE" or "LAYER," whichever was selected in "ADVANCED."

#### ◆BIT RATE

Bit rate refers to the amount of video/audio data per second in a disc. While playing a disc, an approximate bit rate of the playback picture is displayed as Mbps (Mega bit per second) and the audio as kbps (kilo bit per second). The higher the bit rate, the larger the amount of data. However, this does not always mean that you can get higher quality pictures or sounds.

#### ◆LAYER

Indicates the approximate point where the disc is playing.

If it is a dual-layer DVD, the player indicates which layer is being read ("Layer 0" or "Layer 1").

For details on the layers, see page 82 (DVD VIDEO).

## Checking the play information of a DVD (ADVANCED)

- 1 Press DISPLAY during playback.  
The Control Menu is displayed.
- 2 Press  $\uparrow/\downarrow$  to select (ADVANCED), then press ENTER.  
The options for "ADVANCED" appear.

- 3 Press  $\uparrow/\downarrow$  to select items.  
For each item, see "Displays of each item" below.
  - BIT RATE: displays the bit rate.
  - LAYER: displays the layer and the pick-up point.

- 4 Press ENTER.

### To close the ADVANCED window

Select "OFF" in step 3.

# Checking the play information of a DATA CD **DATA CD**

By pressing TIME/TEXT while playing MP3 audio tracks on a DATA CD, you can display the audio bit rate (the amount of data per second of the current audio).

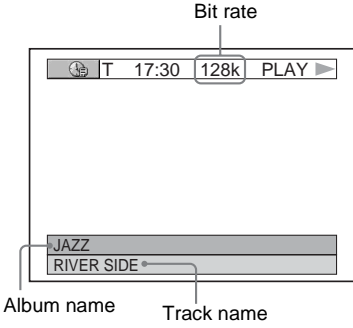

## Changing the Sound

**DVD-V DVD-RW VCD CD**

**DATA CD**

When playing a DVD recorded in multiple audio formats (PCM, Dolby Digital, or DTS), you can change the audio format. If the DVD is recorded with multilingual tracks, you can also change the language.

With CDs, DATA CDs, or VIDEO CDs, you can select the sound from the right or left channel and listen to the sound of the selected channel through both the right and left speakers. For example, when playing a disc containing a song with the vocals on the right channel and the instruments on the left channel, you can hear the instruments from both speakers by selecting the left channel.

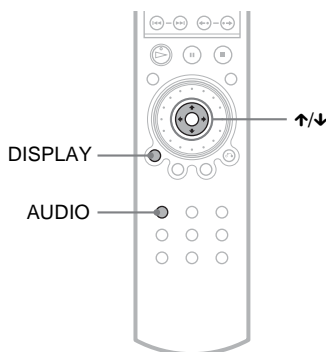

### 1 Press AUDIO during playback.

The following display appears.

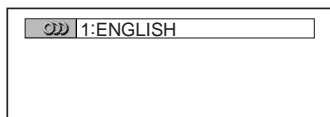

### 2 Press AUDIO repeatedly to select the desired audio signal.

#### ◆ When playing a DVD VIDEO

Depending on the DVD VIDEO, the choice of language varies.

When 4 digits are displayed, they indicate a language code. Refer to “Language Code List” on page 86 to see which language the code represents.

When the same language is displayed two or more times, the DVD VIDEO is recorded in multiple audio formats.

#### ◆ When playing a DVD-RW

The types of sound tracks recorded on a disc are displayed. The default setting is underlined.

Example:

- 1: MAIN (main sound)
- 1: SUB (sub sound)
- 1: MAIN+SUB (main and sub sound)

#### ◆ When playing a VIDEO CD, CD, or DATA CD (MP3 audio)

The default setting is underlined.

- STEREO: The standard stereo sound
- 1/L: The sound of the left channel (monaural)
- 2/R: The sound of the right channel (monaural)

#### ◆ When playing a Super VCD

The default setting is underlined.

- 1:STEREO: The stereo sound of the audio track 1
- 1:1/L: The sound of the left channel of the audio track 1 (monaural)
- 1:2/R: The sound of the right channel of the audio track 1 (monaural)
- 2:STEREO: The stereo sound of the audio track 2
- 2:1/L: The sound of the left channel of the audio track 2 (monaural)
- 2:2/R: The sound of the right channel of the audio track 2 (monaural)

#### Hint

You can also select “AUDIO” from the Control Menu (page 13).

**Notes**

- While playing a Super VCD on which the audio track 2 is not recorded, no sound will come out when you select “2:STEREO,” “2:1/L,” or “2:2/R.”
- You cannot change the sound for Super Audio CDs.

- S: Rear (monaural): The rear component of the Dolby Surround processed signal and the Dolby Digital signal
- LFE: Low Frequency Effect signal

**Hint**

When playing Dolby Digital or DTS sound tracks, “LFE” is encoded in a dotted line when the LFE signal is not being output.

**Displaying the audio information of the disc DVD-V**

Press DISPLAY during playback to display the Control Menu. Select “AUDIO” using  $\uparrow/\downarrow$ . The channels being played are displayed on the screen.

For example, in Dolby Digital format, multiple signals ranging from monaural to 5.1 channel signals can be recorded on a DVD VIDEO. Depending on the DVD VIDEO, the number of the recorded channels may differ.

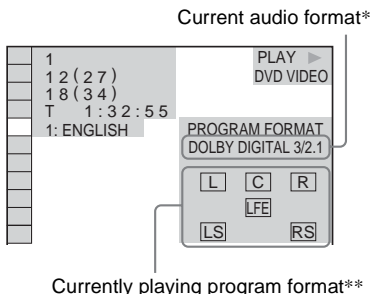

\*\*“PCM,” “DTS,” or “DOLBY DIGITAL” is displayed. In the case of “DOLBY DIGITAL,” the channels in the playing track are displayed by numbers as follows:

For Dolby Digital 5.1 ch:

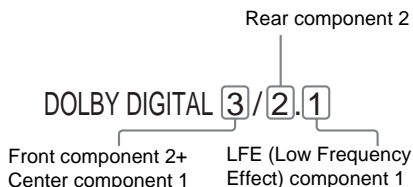

\*\*The letters in the program format display indicate the following sound components:

- L: Front (left)
- R: Front (right)
- C: Center
- LS: Rear (left)
- RS: Rear (right)

# SURROUND Mode

## Settings **DVD-V** **DVD-RW** **VCD**

### **CD** **DATA CD**

You can enjoy surround sound while playing discs recorded in the Dolby Surround (Pro Logic) format.

This function is available when you connect 4 or more speakers and set "REAR" in "SIZE" of "SPEAKER SETUP" to any setting other than "NONE."

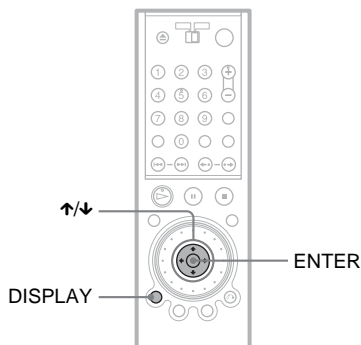

### 1 Press DISPLAY during playback.

The Control Menu is displayed.

### 2 Press ↕/↕ to select (SURROUND), then press ENTER.

The options for "SURROUND" appear.

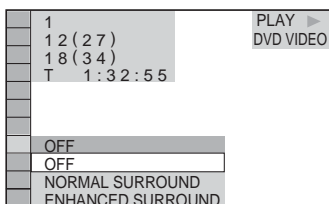

### 3 Press ↕/↕ to select one of the surround modes, then press ENTER.

#### • NORMAL SURROUND

Discs with 2 channel audio signals are decoded with the Dolby Surround (Pro Logic) decoder to create surround effects.

The rear speakers will emit identical monaural sounds. If you are using a center speaker, the appropriate sounds for the center speaker will be delivered.

#### • ENHANCED SURROUND

Provides a greater sense of presence from a Dolby Surround (Pro Logic) source with a monaural rear channel signal.

Produces a stereo like effect in the rear channels.

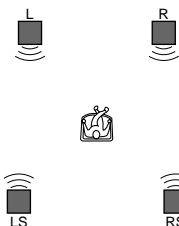

L: Front speaker (left)  
R: Front speaker (right)  
LS: Rear speaker (left)  
RS: Rear speaker (right)

### To cancel the setting

Select "OFF" in step 3.

### Notes

- If you use the DIGITAL OUT (OPTICAL or COAXIAL) jack and set "DOLBY DIGITAL" to "DOLBY DIGITAL" and "DTS" to "DTS" in "AUDIO SETUP", sound will come from your speakers but it will not have the surround effect.
- If the player is set up to output the signal from the DIGITAL OUT (OPTICAL or COAXIAL) jack, the surround effect will not be heard when you play a CD.



## Changing the Angles

### DVD-V

If various angles (multi-angles) for a scene are recorded on the DVD VIDEO, the “ANGLE” indicator lights up in the front panel display. This means that you can change the viewing angle.

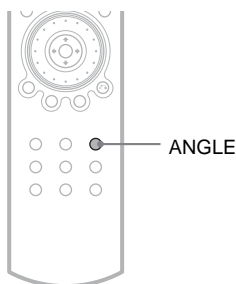

### 1 Press ANGLE during playback.

The number of the angle appears on the display.

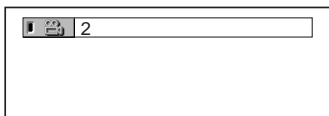

### 2 Press ANGLE repeatedly to select the angle number.

The scene changes to the selected angle.

#### Hint

You can also select “ANGLE” from the Control Menu (page 13).

#### Note

Depending on the DVD VIDEO, you may not be able to change the angles even if multi-angles are recorded on the DVD VIDEO.

## Displaying the Subtitles

### DVD-V DVD-RW

If subtitles are recorded on the discs, you can change the subtitles or turn them on and off whenever you want while playing a DVD.

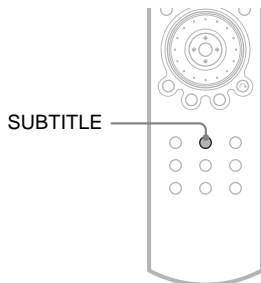

### 1 Press SUBTITLE during playback.

The following display appears.

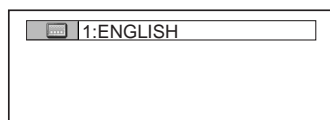

### 2 Press SUBTITLE repeatedly to select the setting.

#### ◆ When playing a DVD VIDEO

Select the language.

Depending on the DVD VIDEO, the choice of language varies.

When 4 digits are displayed, they indicate a language code. Refer to “Language Code List” on page 86 to see which language the code represents.

#### ◆ When playing a DVD-RW

Select “ON.”

### To turn off the subtitles

Select “OFF” in step 2.

#### Hint

You can also select “SUBTITLE” from the Control Menu (page 13).

## Note

Depending on the DVD VIDEO, you may not be able to change the subtitles even if multilingual subtitles are recorded on it. You also may not be able to turn them off.

# Adjusting the Playback Picture (VIDEO CONTROL) **DVD-V**

**DVD-RW** **VCD**

You can adjust the video signal of the DVD or VIDEO CD from the player to obtain the picture quality you want.

Choose the preset Video Control setting that best suits the program you are watching, or select "MEMORY" to adjust individual picture items, such as color, brightness, etc., creating a fixed set of picture item adjustments for the disc in either case.

As long as "PLAYBACK MEMORY" in "CUSTOM SETUP" is set to "ON" (default), the Video Control settings for up to 30 discs remain in the player's memory, and will be automatically applied whenever you play the same disc. When you store a Video Control setting for the 31st disc, the setting for the 1st disc is canceled.

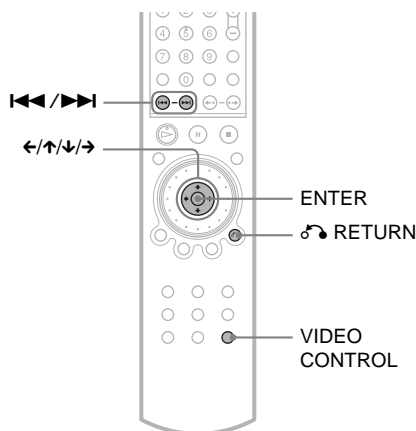

## 1 Press VIDEO CONTROL during playback.

The following display appears.

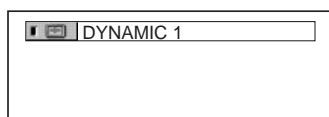

## 2 Press VIDEO CONTROL repeatedly to select the setting you want.

The default setting is underlined.

- **STANDARD**: displays a standard picture.
- **DYNAMIC 1**: produces a bold dynamic picture by increasing the picture contrast and the color intensity.
- **DYNAMIC 2**: produces a more dynamic picture than DYNAMIC 1 by further increasing the picture contrast and the color intensity.
- **CINEMA 1**: enhances details in dark areas by increasing the black level.
- **CINEMA 2**: White colors become brighter and black colors become richer, and the color contrast is increased.
- **MEMORY**: adjusts the picture in greater detail.

### Hints

- When you watch a movie, “CINEMA 1” or “CINEMA 2” is recommended.
- You can also select “VIDEO CONTROL” from the Control Menu (page 13).

## Adjusting the picture items in “MEMORY”

You can adjust each element of the picture qualities individually.

- **DVE (digital video enhancer)**: Sharpens or softens the outlines of the images. “SOFT” is available only for DVDs.
- **BNR (block noise reduction)**: Reduces “block noise” or mosaic like patterns in the picture.
- **Y NR (luminance noise reduction)**: Reduces noise contained in the luminance element of the video signal.
- **C NR (chroma noise reduction)**: Reduces noise contained in the color element of the video signal.
- **CHROMA DELAY**: Adjusts colors that appear to have shifted horizontally.
- **AV ALIGNMENT**: Adjusts delay between the picture and sound.

### • PROGRESSIVE 1:

Sets a threshold at which the player determines the progressive conversion method.

When “COMPONENT OUT” in “SCREEN SETUP” is set to “PROGRESSIVE,” the player automatically detects whether the software is video based or film based, and converts the video signals in the corresponding progressive conversion method. When the set point is closer to “VIDEO,” the video based software conversion is more likely to be selected; when closer to “FILM,” the film based conversion is the likely choice. When set specifically to “VIDEO,” the video based software conversion will be always applied regardless of the software type. See “Glossary” for details about the video based software and film based software (page 82).

### • PROGRESSIVE 2:

Adjusts the progressive video signals processed under the video based software conversion. Set closer to “STILL” for software containing static pictures such as scenery. Or, set closer to “MOVE” for software containing dynamic moving pictures such as a car chase.

### • PICTURE:

Changes the contrast.

### • BRIGHTNESS:

Changes the overall brightness.

### • COLOR:

Makes the colors deeper or lighter.

### • HUE:

Changes the color balance.

### • GAMMA:

Adjusts the brightness of selected areas. See “Adjusting the brightness of selected areas (Gamma Correction)” for details (page 60).

## 1 Press VIDEO CONTROL repeatedly to select “MEMORY,” then press ENTER.

The “DVE” adjustment bar appears.

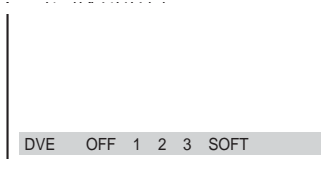

2 Press ←/→ to adjust the outline, then press ENTER.

The adjustment is saved, and the “BNR” adjustment bar appears.

3 Repeat step 2 to adjust “BNR” and the other items such as “Y NR,” and “C NR.”

4 When you reach the “GAMMA” adjustment bar, press ↓.

Video Control display 1 appears. To go to Video Control display 2, press ↓ again.

You can check all the adjustments other than “GAMMA.”

Video Control display 1

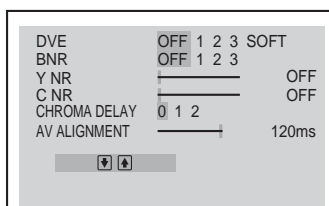

Video Control display 2

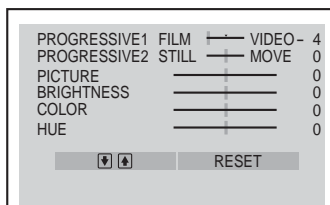

## To turn off the display

Press ↵ RETURN.

### 💡 Hints

- To reset the picture items to the default values, press → after step 4 to select “RESET” in Video Control display 2 and press ENTER.
- You can skip the adjustment without saving by pressing ↑/↓ in step 2.
- Video based software, such as TV drama, animation, and live music software are more adequately processed under the video based conversion. Film based software such as movies are better processed under the film based conversion.

## Notes

- If the outlines of the images on your screen should become blurred, set “BNR” to “OFF.”
- Depending on the disc or the scene being played, the “BNR,” “Y NR,” or “C NR” effect may be hard to discern.
- Depending on the disc or the scene being played, noise found in the disc may become more apparent. If this happens, it is recommended that you use the BNR function with the DVE function. If the condition still does not improve, reduce the DVE level, or select “SOFT” (DVD only).
- Some DVDs contain both video based and film based sections. For example, a DVD may contain a movie taken on film, and a “Making of” sequence taken on video.
- If the progressive format image becomes unclear or unnatural when “MEMORY” is set to “PROGRESSIVE 1” or “PROGRESSIVE 2,” try viewing with “PROGRESSIVE 1” set to “VIDEO.” If this does not improve the picture, view the images in Interlace format through the COMPONENT VIDEO OUT jacks (page 72), or switch to another jack.
- The values set for “DVE” and “BNR” in “MEMORY” are valid even if you select “STANDARD,” “DYNAMIC 1,” “DYNAMIC 2,” “CINEMA 1,” or “CINEMA 2.”

## Adjusting the brightness of selected areas (Gamma Correction)

Depending on your TV or viewing environment, images on the screen may lose definition when a certain area of the image is so light that it appears washed out, or so dark that it blends into the surrounding dark areas. By correcting the Gamma value, you can adjust the brightness of selected areas to get a clearer image. While the “BRIGHTNESS” adjustment controls the brightness of the entire image, the “GAMMA” adjustment is useful when only some portions of the image need adjusting.

Example: You are watching a movie that is rich in shadows and you want to see the hidden details of the scenery. If you use the “BRIGHTNESS” adjustment, the entire image will become brighter, losing definition in the areas that were initially bright. The “GAMMA” adjustment enables you to select the dark part and gradually increase its brightness without sacrificing the overall definition.

- After step 3 of "Adjusting the picture items in MEMORY," press  $\uparrow/\downarrow$  to display the "GAMMA," adjustment bar, and press ENTER or  $\rightarrow$ .

The "GAMMA" adjustment display appears.

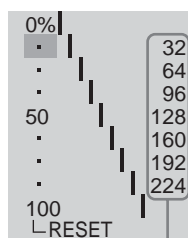

Current Gamma setup value

- Press  $\uparrow/\downarrow$  to select areas of an image.

The upper region adjusts the dark areas and the lower region adjusts the light areas.

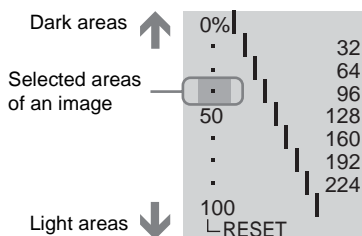

- Press  $\leftarrow/\rightarrow$  to adjust the brightness level of the area that you selected.

$\leftarrow$  decreases the level (darkens the area), and  $\rightarrow$  increases the level (lightens the area). The level can be adjusted between 16 and 235. The level for the dark areas can never be greater than the light areas.

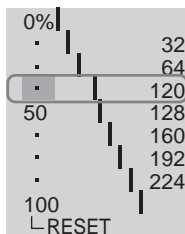

Gamma value and the position of the bar change in accordance with your adjustment

$\leftarrow$  Darken       $\rightarrow$  Lighten

- Repeat steps 2 and 3 to adjust the brightness level of other areas that you select.

Try to keep the line that connects the brightness level of each area as smooth and straight as possible, as shown below.

How to lighten the dark areas of an image

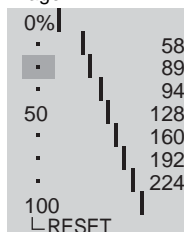

How to darken the light areas of an image

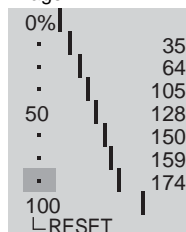

To prevent the image from appearing overly altered, do not give the line any sharp changes. Gradually make the adjustments while viewing the image on your TV screen.

Press  $\rightarrow$  RETURN to stop making adjustments to the image.

- Press ENTER.

The "GAMMA" adjustment bar appears and the adjusted gamma values are stored in memory.

To reset only the gamma value to the default setting

Select "RESET" in the "GAMMA" adjustment display by pressing  $\uparrow/\downarrow$ , and press ENTER twice.

#### Hint

You can move the gamma adjustment display horizontally by pressing  $\leftarrow/\rightarrow$ .

## Using Various Additional Functions

### Locking Discs (CUSTOM

### PARENTAL CONTROL, PARENTAL CONTROL)

You can set two kinds of playback restrictions for the desired disc.

- Custom Parental Control

You can set playback restrictions so that the player will not play inappropriate discs.

- Parental Control

Playback of some DVD VIDEOS can be limited according to a predetermined level such as the age of the users. Scenes may be blocked or replaced with different scenes.

The same password is used for both Parental Control and Custom Parental Control.

### Custom Parental Control DVD-V

VCD SA-CD CD

You can set the same Custom Parental Control password for up to 40 discs. When you set the 41st-disc, the first disc is canceled.

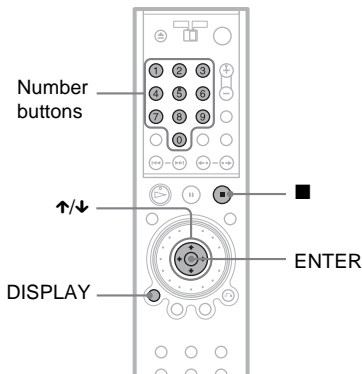

**1** Insert the disc you want to lock.  
If the disc is playing, press ■ to stop playback.

**2** Press DISPLAY while the player is in stop mode.  
The Control Menu appears.

**3** Press ↑/↓ to select  (PARENTAL CONTROL), then press ENTER.

The options for "PARENTAL CONTROL" appear.

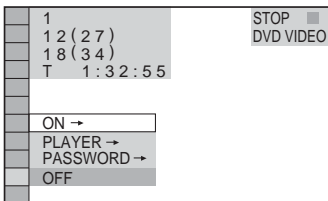

**4** Press ↑/↓ to select "ON →," then press ENTER.

◆ If you have not entered a password  
The display for registering a new password appears.

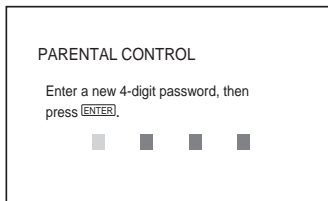

Enter a 4-digit password using the number buttons, then press ENTER.  
The display for confirming the password appears.

◆ When you have already registered a password  
The display for entering the password appears.

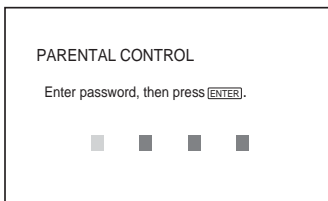

**5** Enter or re-enter your 4-digit password using the number buttons, then press ENTER.

"Custom parental control is set." appears and the screen returns to the Control Menu.

## To turn off the Custom Parental Control function

- 1 Follow steps 1 through 3 of “Custom Parental Control.”
- 2 Press **↑/↓** to select “OFF →,” then press ENTER.
- 3 Enter your 4-digit password using the number buttons, then press ENTER.

## To play a disc for which Custom Parental Control is set

- 1 Insert the disc for which Custom Parental Control is set.  
The “CUSTOM PARENTAL CONTROL” display appears.
- 2 Enter your 4-digit password using the number buttons, then press ENTER.  
The player is ready for playback.

### **Hint**

If you forget your password, enter the 6-digit number “199703” using the number buttons when the “CUSTOM PARENTAL CONTROL” display asks you for your password, then press ENTER. The display will ask you to enter a new 4-digit

◆ **When you have already registered a password**

The display for entering the password appears.

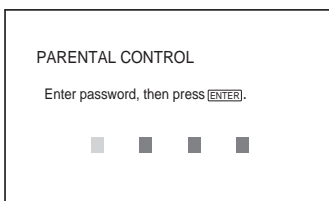

**4** Enter or re-enter your 4-digit password using the number buttons, then press ENTER.

The display for setting the playback limitation level appears.

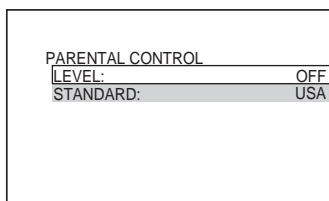

**5** Press  $\uparrow/\downarrow$  to select "STANDARD," then press ENTER.

The selection items for "STANDARD" are displayed.

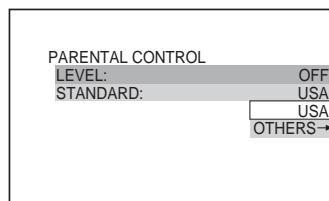

**6** Press  $\uparrow/\downarrow$  to select a geographic area as the playback limitation level, then press ENTER.

The area is selected.

When you select "OTHERS  $\rightarrow$ ," select and enter a standard code in the table on page 65 using the number buttons.

**7** Press  $\uparrow/\downarrow$  to select "LEVEL," then press ENTER.

The selection items for "LEVEL" are displayed.

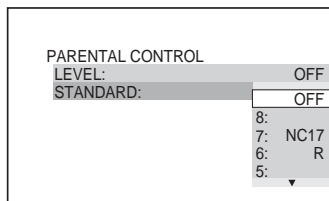

**8** Select the level you want using  $\uparrow/\downarrow$ , then press ENTER.

Parental Control setting is complete.

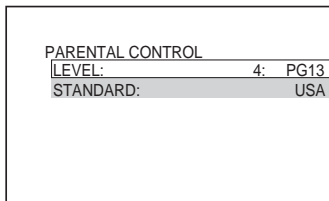

The lower the value, the stricter the limitation.

**To turn off the Parental Control function**

Set "LEVEL" to "OFF" in step 8.

**To play a disc for which Parental Control is set**

- 1 Insert the disc and press  $\triangleright$ .  
The display for entering your password appears.
- 2 Enter your 4-digit password using the number buttons, then press ENTER.  
The player starts playback.

**Hint**

If you forget your password, remove the disc and repeat steps 1 to 3 of "Parental Control (limited playback)." When you are asked to enter your password, enter "199703" using the number buttons, then press ENTER. The display will ask you to enter a new 4-digit password. After you enter a new 4-digit password, replace the disc in the player and press  $\triangleright$ . When the display for entering your password appears, enter your new password.

**Notes**

- When you play discs which do not have the Parental Control function, playback cannot be limited on this player.



- Depending on the disc, you may be asked to change the parental control level while playing the disc. In this case, enter your password, then change the level. If the Resume Play mode is canceled, the level returns to the previous level.

## Area Code

Standard	Code number
Argentina	2044
Australia	2047
Austria	2046
Belgium	2057
Brazil	2070
Canada	2079
Chile	2090
China	2092
Denmark	2115
Finland	2165
France	2174
Germany	2109
India	2248
Indonesia	2238
Italy	2254
Japan	2276
Korea	2304

## Changing the password

- 1 Press **DISPLAY** while the player is in stop mode.  
The Control Menu appears.
- 2 Press **↑/↓** to select **(PARENTAL CONTROL)**, then press **ENTER**.  
The options for “PARENTAL CONTROL” appear.
- 3 Press **↑/↓** to select “**PASSWORD →**,” then press **ENTER**.  
The display for entering the password appears.
- 4 Enter your 4-digit password using the number buttons, then press **ENTER**.
- 5 Enter a new 4-digit password using the number buttons, then press **ENTER**.
- 6 To confirm your password, re-enter it using the number buttons, then press **ENTER**.

### If you make a mistake entering your password

Press **←** before you press **ENTER** and input the correct number.

### If you make a mistake

Press **↶** RETURN.

### To turn off the display

Press **DISPLAY** repeatedly until the display is turned off.

---

# Operation Sound Effects

## (Sound Feedback)

The player beeps when the following operations are performed.

The default setting of the Sound Feedback function is set to off.

Operation	Operation sound
Power is turned on	One beep
Power is turned off	Two beeps
▷ is pressed	One beep
⏏ is pressed	Two beeps
Playback is stopped	One long beep
Operation is not possible	Three beeps

### To turn off the Sound Feedback function

When there is no disc in the player, press and hold ⏏ on the player for more than two seconds. You will hear two beeps and the Sound Feedback function is turned off.

---

## Setting Sound Feedback

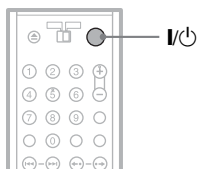
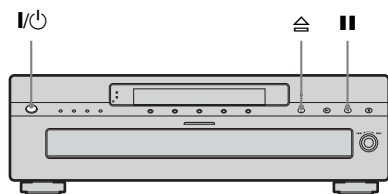

- 1 Press I/O on the player or the remote.**  
The player turns on.  
When there is a disc in the player, press ⏏ and remove the disc. Then press ⏏ again to close the disc tray.
  - 2 Press and hold ⏏ on the player for more than two seconds.**  
You will hear one beep and the Sound Feedback function is turned on.
-

# Controlling Your TV or AV Amplifier (Receiver) With the Supplied Remote

By adjusting the remote signal, you can control your TV with the supplied remote. If you connect the player to an AV amplifier (receiver), you can control the volume with the supplied remote.

## Notes

- Depending on the connected unit, you may not be able to correctly control your TV or AV amplifier (receiver) using some of the buttons below.
- If you enter a new code number, the code number previously entered will be erased.
- When you replace the batteries of the remote, the code number you have set may be reset to the default setting. Set the appropriate code number again.

## Controlling TVs with the remote

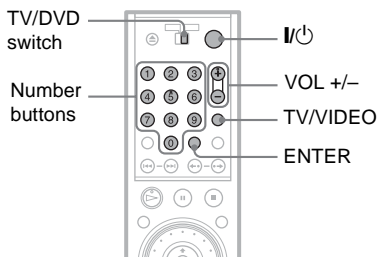

- 1 Slide the TV/DVD switch to TV.
- 2 Hold down I/⏻, and enter your TV's manufacturer code (see "Code numbers of controllable TV's" below) using the number buttons.
- 3 Release I/⏻.

When the TV/DVD switch is set to TV, the remote performs the following:

I/⏻	Turns the TV on or off
VOL +/-	Adjusts the volume of the TV
TV/VIDEO	Switches the TV's input source between the TV and other input sources The button works even if the TV/DVD switch is set to DVD
Number buttons and ENTER	Selects the channel of the TV

## Code numbers of controllable TVs

If more than one code number is listed, try entering them one at a time until you find the one that works with your TV.

Manufacturer	Code number
Sony	01 (default)
Akai	04
AOC	04
Centurion	12
Coronado	03
Curtis-Mathes	12
Daytron	12
Emerson	03, 04, 14
Fisher	11
General Electric	06, 10
Gold Star	03, 04, 17
Hitachi	02, 03
J.C.Penney	04, 12
JVC	09
KMC	03
Magnavox	03, 08, 12
Marantz	04, 13
MGA/Mitsubishi	04, 12, 13, 17
NEC	04, 12
Panasonic	06, 19
Philco	03, 04
Philips	08, 21
Pioneer	16

Manufacturer	Code number
Portland	03
Proscan	10
Quasar	06, 18
Radio Shack	05, 14
RCA	04, 10
Sampo	12
Samsung	03, 12, 20
Sanyo	11, 14
Scott	12
Sears	07, 10, 11
Sharp	03, 05, 18
Sylvania	08, 12
Teknika	03, 08, 14
Toshiba	07
Wards	03, 04, 12
Yorx	12
Zenith	15

## Controlling the volume of your AV amplifier (receiver) with the remote

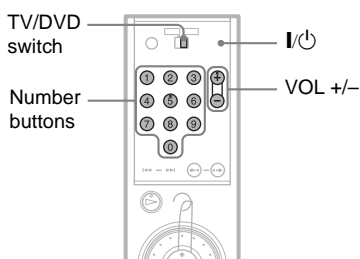

- 1 Slide the TV/DVD switch to DVD.
- 2 Hold down I/⏻, and enter your AV amplifier (receiver)'s manufacturer's code (see the table below) using the number buttons.
- 3 Release I/⏻.  
The VOL +/- buttons control the AV amplifier's volume.  
◆ If you want to control the TV's volume  
Slide the TV/DVD switch to TV.

## Code numbers of controllable AV amplifiers (receivers)

If more than one code number is listed, try entering them one at a time until you find the one that works with your AV amplifier (receiver).

Manufacturer	Code number
Sony*	80, 88, 89, 91
Denon	84, 85, 86
Kenwood	92, 93
Onkyo	81, 82, 83
Pioneer	99
Sansui	87
Technics	97, 98
Yamaha	94, 95, 96

\* If you cannot control the volume of Sony STR-DA3000ES/DA5000ES/DA9000ES AV amplifiers (receivers) with the remote, enter the code number 91 and check that the command mode of the amplifier (receiver) is set to "COMMAND MODE [AV1]."

See the instructions supplied with the amplifier (receiver) to change the command mode.

For Sony amplifiers (receivers) other than STR-DA3000ES/DA5000ES/DA9000ES, see the instructions supplied with the amplifiers (receivers).

### 💡 Hint

If you want to control the TV's volume even when the TV/DVD switch is set to DVD, repeat steps 1 and 2 and enter the code number 90 (default).

## Using the Setup Display

By using the Setup Display, you can make various adjustments to items such as picture and sound. You can also set a language for the subtitles and the Setup Display, among other things. For details on each Setup Display item, see pages from 70 to 78.

### Note

Playback settings stored in the disc take priority over the Setup Display settings and not all the functions described may work.

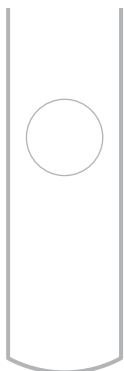

- 1** Press **DISPLAY** when the player is in stop mode.

The Control Menu appears.

- 2** Press **↑/↓** to select **(SETUP)**, then press **ENTER**.

The options for “SETUP” appear.

- 3** Press **↑/↓** to select “CUSTOM,” then press **ENTER**.

The Setup Display appears.

- 4** Press **↑/↓** to select the setup item from the displayed list:  
“LANGUAGE SETUP,” “SCREEN SETUP,” “CUSTOM SETUP,” “AUDIO SETUP,” or “SPEAKER SETUP.” Then press **ENTER**.

The Setup item is selected.

Example: “SCREEN SETUP”

- 5** Select an item using **↑/↓** and press **ENTER**.

The options for the selected item appear.  
Example: “TV TYPE”

## 6 Select a setting using $\uparrow/\downarrow$ , then press ENTER.

The setting is selected and setup is complete.

Example: "16:9"

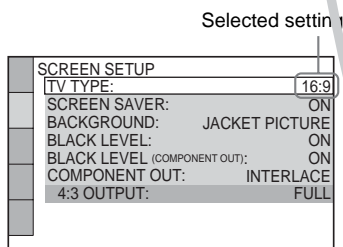

### To turn off the display

Press DISPLAY repeatedly until the display is turned off.

### To enter the Quick Setup mode

Select "QUICK" in step 3. Follow from step 5 of the Quick Setup explanation to make basic adjustments (page 27).

### To reset all of the "SETUP" settings

- 1 Select "RESET" in step 3 and press ENTER.
- 2 Select "YES" using  $\uparrow/\downarrow$ .  
You can also quit the process and return to the Control Menu by selecting "NO" here.
- 3 Press ENTER.  
All the settings explained on pages 70 to 78 return to the default settings. Do not press  $\text{I/O}$  while resetting the player as it takes a few seconds to complete.

## Setting the Display or Sound Track Language

### (LANGUAGE SETUP)

"LANGUAGE SETUP" allows you to set various languages for the on-screen display or sound track.

Select "LANGUAGE SETUP" in the Setup Display. To use the display, see "Using the Setup Display" (page 69).

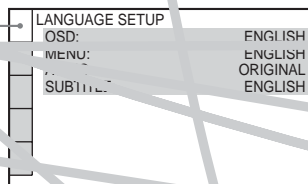

#### ◆ OSD (On-Screen Display)

Switches the display language on the screen.

#### ◆ MENU (DVD VIDEO only)

You can select the desired language for the disc's menu.

#### ◆ AUDIO (DVD VIDEO only)

Switches the language of the sound track. When you select "ORIGINAL," the language given priority in the disc is selected.

#### ◆ SUBTITLE (DVD VIDEO only)

Switches the language of the subtitle recorded on the DVD VIDEO. When you select "AUDIO FOLLOW," the language for the subtitles changes according to the language you selected for the sound track.

#### 💡 Hint

If you select "OTHERS  $\rightarrow$ " in "MENU," "SUBTITLE," or "AUDIO," select and enter a language code from "Language Code List" on page 86 using the number buttons.

#### Note

When you select a language in "MENU," "SUBTITLE," or "AUDIO" that is not recorded on the DVD VIDEO, one of the recorded languages will be automatically selected.

# Settings for the Display

## (SCREEN SETUP)

Choose settings according to the TV to be connected.

Select "SCREEN SETUP" in the Setup Display. To use the display, see "Using the Setup Display" (page 69).

The default settings are underlined.

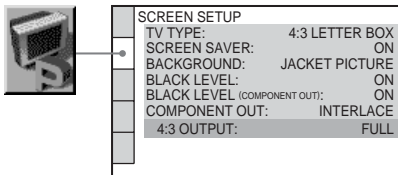

### ◆ TV TYPE

Selects the aspect ratio of the connected TV (4:3 standard or wide).

<u>4:3 LETTER BOX</u>	Select this when you connect a 4:3 screen TV. Displays a wide picture with bands on the upper and lower portions of the screen.
4:3 PAN SCAN	Select this when you connect a 4:3 screen TV. Automatically displays a wide picture on the entire screen and cuts off the portions that do not fit.
16:9	Select this when you connect a wide-screen TV or a TV with a wide mode function.

4:3 LETTER BOX



4:3 PAN SCAN



16:9



### Note

Depending on the DVD, "4:3 LETTER BOX" may be selected automatically instead of "4:3 PAN SCAN" or vice versa.

### ◆ SCREEN SAVER

The screen saver image appears when you leave the player in pause or stop mode for 15 minutes, or when you play back a Super Audio CD, CD, or DATA CD (MP3 audio) for more than 15 minutes. The screen saver will help prevent your display device from becoming damaged (ghosting). Press  $\triangleright$  to turn off the screen saver.

<u>ON</u>	Turns on the screen saver.
OFF	Turns off the screen saver.

### ◆ BACKGROUND

Selects the background color or picture on the TV screen in stop mode or while playing a Super Audio CD, CD, or DATA CD (MP3 audio).

<u>JACKET PICTURE</u>	The jacket picture (still picture) appears, but only when the jacket picture is already recorded on the disc (CD-EXTRA, etc.). If the disc does not contain a jacket picture, the "GRAPHICS" picture appears.
GRAPHICS	A preset picture stored in the player appears.
BLUE	The background color is blue.
BLACK	The background color is black.

### ◆ BLACK LEVEL

Selects the black level (setup level) for the video signals output from the jacks other than COMPONENT VIDEO OUT.

<u>ON</u>	Sets the black level of the output signal to the standard level.
OFF	Lowers the standard black level. Use this when the picture becomes too white.

### ◆ BLACK LEVEL (COMPONENT OUT)

Selects the black level (setup level) for the video signals output from the COMPONENT VIDEO OUT jacks.

You cannot select this when “PROGRESSIVE” is selected in “COMPONENT OUT” (see below).

<u>ON</u>	Sets the black level of the output signal to the standard level.
OFF	Lowers the standard black level. Use this when the picture becomes too white.

### ◆ COMPONENT OUT

Selects the type of the signal output from the COMPONENT VIDEO OUT jacks when the COMPONENT VIDEO OUT/SCAN SELECT switch on the rear panel of the player is set to SELECTABLE. See page 83 for more information about the different types.

<u>INTERLACE</u>	Select this when you are connected to a standard (interlace format) TV.
PROGRESSIVE	Select this when you have a TV that can accept progressive signals.

### About the COMPONENT VIDEO OUT/SCAN SELECT switch

The COMPONENT VIDEO OUT/SCAN SELECT switch on the rear panel of the player selects the signal output from the COMPONENT VIDEO OUT jacks: interlace, progressive, or selectable. The switch takes priority over the setting made in “COMPONENT OUT.”

### To switch the video signal format

If you have selected “PROGRESSIVE” for a TV that does not accept signals in progressive format 480p, or if the software’s video signals are not suited for progressive video signal conversion, view the image in Interlace format.

- 1 Set the COMPONENT VIDEO OUT/SCAN SELECT switch on the rear panel of the player to INTERLACE. “COMPONENT OUT” is automatically set to “INTERLACE.”

- 2 Reset the COMPONENT VIDEO OUT/SCAN SELECT switch to SELECTABLE.

Normally leave the switch in this position when using the COMPONENT VIDEO OUT jacks.

### When “PROGRESSIVE” is selected in “COMPONENT OUT”

- 4:3 OUTPUT

Adjust this when you watch progressive signals on a standard 4:3 aspect ratio television. If you can change the aspect ratio on your progressive format (480p) compatible TV, change the setting on your TV, not the player.

<u>FULL</u>	Select this when you can change the aspect ratio on your TV.
NORMAL	Select this when you cannot change the aspect ratio on your TV. Shows a 16:9 aspect ratio signal with black bands on left and right sides of the image, and a 4:3 aspect ratio signal with black bands on all sides of the image.

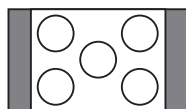

16:9 aspect ratio TV

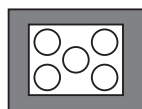

4:3 aspect ratio TV



---

## Custom Settings (CUSTOM SETUP)

Use this to set up playback related and other settings.

Select “CUSTOM SETUP” in the Setup Display. To use the display, see “Using the Setup Display” (page 69).

The default settings are underlined.

### ◆ AUTO POWER OFF

Switches the Auto Power Off setting on or off.

<u>OFF</u>	Switches this function off.
ON	The player enters standby mode when left in stop mode for more than 30 minutes.

### ◆ AUTO PLAY

Switches the Auto Play setting on or off. This function is useful when the player is connected to a timer (not supplied).

<u>OFF</u>	Switches this function off.
ON	Automatically starts playback when the disc is inserted.

### ◆ DIMMER

Adjusts the lighting of the front panel display.

### ◆ PAUSE MODE (DVD VIDEO/DVD-RW only)

Selects the picture in pause mode.

### ◆ PLAYBACK MEMORY

The player can store “SUBTITLE” and other settings of each disc for up to 30 discs (Playback Memory).

Set this function “ON” or “OFF.”

The following settings are stored in memory.

- ANGLE (page 57)\*
- AUDIO (page 54)\*
- VIDEO CONTROL (page 58)\*\*
- SUBTITLE (page 57)\*

\* DVD VIDEO only

\*\* DVD VIDEO/VIDEO CD only

### Note

The player can store the settings of up to 30 discs. When you store the setting of disc number 31, the first disc setting is canceled.

### ◆ TRACK SELECTION (DVD VIDEO only)

Gives the sound track which contains the highest number of channels priority when you play a DVD VIDEO on which multiple audio formats (PCM, DTS, or Dolby Digital format) are recorded.

### Notes

- When you set the item to “AUTO,” the language may change. The “TRACK SELECTION” setting has higher priority than the “AUDIO” settings in “LANGUAGE SETUP” (page 70).
- If PCM, DTS, and Dolby Digital sound tracks have the same number of channels, the player

selects PCM, DTS, and Dolby Digital sound tracks in this order.

◆ **MULTI-DISC RESUME (DVD VIDEO/VIDEO CD only)**

Switches the Multi-disc Resume setting on or off. Resume playback point can be stored in memory for up to 40 different DVD VIDEO/VIDEO CD discs (page 34).

<u>ON</u>	Stores the resume settings in memory for up to 40 discs (The settings remain in memory even if you select "OFF.")
OFF	Does not store the resume settings in memory. Playback restarts at the resume point only for the current disc in the player.

◆ **CD DIRECT**

Eliminates the use of unnecessary circuits when playing CDs. This setting will be activated when you open or close the disc tray.

This function affects the output from the following jacks:

- AUDIO OUT L/R 1/2 jacks
- 5.1CH OUTPUT jacks

<u>OFF</u>	Select this when playing CD discs, including CDs with DTS tracks.
ON	Eliminates the use of unnecessary circuits needed to play CDs.

**Note**

If you select "ON" when playing CDs with DTS tracks, the sound will become noisy.

## Settings for the Sound (AUDIO SETUP)

"AUDIO SETUP" allows you to set the sound according to the playback and connection conditions.

Select "AUDIO SETUP" in the Setup Display. To use the display, see "Using the Setup Display" (page 69).

The default settings are underlined.

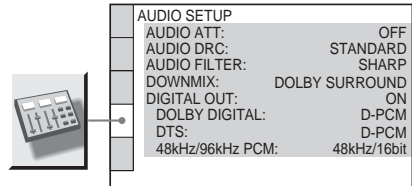

◆ **AUDIO ATT (attenuation)**

If the playback sound is distorted, set this item to "ON." The player reduces the audio output level.

This function affects the output of the following jacks:

- AUDIO OUT L/R 1/2 jacks
- 5.1CH OUTPUT jacks

<u>OFF</u>	Normally, select this position.
ON	Select this when the playback sound from the speakers is distorted.

◆ **AUDIO DRC (Dynamic Range Control) (DVD only)**

Makes the sound clear when the volume is turned down when playing a DVD that conforms to "AUDIO DRC." This affects the output from the following jacks:

- AUDIO OUT L/R 1/2 jacks
- 5.1CH OUTPUT jacks
- DIGITAL OUT (OPTICAL or COAXIAL) jack only when "DOLBY DIGITAL" is set to "D-PCM" (page 75).

<u>STANDARD</u>	Normally select this position.
TV MODE	Makes the low sounds clear even if you turn the volume down.
WIDE RANGE	Gives you the feeling of being at a live performance.

### ◆ AUDIO FILTER (except Super Audio CD)

Selects the digital filter to reduce noise above 22.05 kHz (Sampling frequency (Fs) of the audio source is 44.1 kHz), 24 kHz (Fs is 48 kHz), or 48 kHz (Fs is above 96 kHz).

<b>SHARP</b>	Provides a wide frequency range and spatial feeling.
<b>SLOW</b>	Provides smooth and warm sound.

### Note

There may be little effect by changing the digital filter depending on discs or playback environment.

### ◆ DOWNMIX (DVD only)

Switches the method for mixing down to 2 channels when you play a DVD which has rear sound elements (channels) or is recorded in Dolby Digital format. For details on the rear signal components, see “Displaying the audio information of the disc” (page 55). This function affects the output of the following jacks:

- AUDIO OUT L/R 1/2 jacks
- DIGITAL OUT (OPTICAL or COAXIAL) jack when “DOLBY DIGITAL” and “DTS” is set to “D-PCM” (page 75).

<b>DOLBY SURROUND</b>	Normally select this position. Multi-channel audio signals are output to two channels for enjoying surround sounds.
<b>NORMAL</b>	Multi-channel audio signals are downmixed to two channels for use with your stereo.

### ◆ DIGITAL OUT

Select this if audio signals are to be output via the DIGITAL OUT (OPTICAL or COAXIAL) jack.

<b>ON</b>	Normally select this position. When you select “ON,” see “To set the digital output signal” for further settings.
<b>OFF</b>	The influence of the digital circuit upon the analog circuit is minimal.

### Note

Super Audio CD audio signals are not output from a digital jack.

### To set the digital output signal

The following switch the method of outputting audio signals when you connect a component such as an amplifier (receiver) or MD deck with a digital input jack.

For connection details, see page 21. Select “DOLBY DIGITAL,” “DTS,” and “48 kHz/96 kHz PCM” after setting “DIGITAL OUT” to “ON.”

AUDIO SETUP	
AUDIO ATT:	OFF
AUDIO DRC:	STANDARD
AUDIO FILTER:	SHARP
DOWNMIX:	DOLBY SURROUND
DIGITAL OUT:	ON
DOLBY DIGITAL:	D-PCM
DTS:	D-PCM
48kHz/96kHz PCM:	48kHz/16bit

If you connect a component that does not conform to the selected audio signal, a loud noise (or no sound) will come out from the speakers, damaging your ears or speakers.

### • DOLBY DIGITAL (DVD only)

Selects the type of Dolby Digital signal.

<b>D-PCM</b>	Select this when the player is connected to an audio component without a built-in Dolby Digital decoder. You can select whether the signals conform to Dolby Surround (Pro Logic) or not by making adjustments to the “DOWNMIX” item in “AUDIO SETUP” (page 75).
<b>DOLBY DIGITAL</b>	Select this when the player is connected to an audio component with a built-in Dolby Digital decoder.

### • DTS (DVD VIDEO only)

Selects the type of DTS signal.

<b>D-PCM</b>	Select this when the player is connected to an audio component without a built-in DTS decoder. If you play DTS audio sound tracks, the player outputs stereo signals via the DIGITAL OUT (OPTICAL or COAXIAL) jacks.
<b>DTS</b>	Select this when the player is connected to an audio component with a built-in DTS decoder.

- 48kHz/96kHz PCM (DVD VIDEO only)  
Selects the sampling frequency of the audio signal.

48kHz/16bit	The audio signals of DVD VIDEOS are always converted to 48kHz/16bit.
96kHz/24bit	All types of signals including 96kHz/24bit are output in their original format. However, if the signal is encrypted for copyright protection purposes, the signal is only output as 48kHz/16bit.

### Notes

- Even if you set “48kHz/96kHz PCM” to “96kHz/24bit,” the sampling frequency is converted to 48kHz/16bit when a “SURROUND” mode (page 56) is selected.
- The analog audio signals from the AUDIO OUT L/R jacks and 5.1CH OUTPUT jacks are not affected by this setting and keep their original sampling frequency level.

## Settings for the Speakers

### (SPEAKER SETUP)

To obtain the best possible surround sound, set the size of the speakers you have connected and their distance from your listening position. Then use the test tone to adjust the volume and the balance of the speakers to the same level.

This setting is effective when connecting the speaker with 5.1 CH OUTPUT jacks (page 25).

You can create two different Speaker Setup settings, one for Super Audio CDs and one for all other types of discs.

- 1 Follow steps 1 through 4 of “Using the setup display” (page 69) to select “SPEAKER SETUP” in the Setup display.

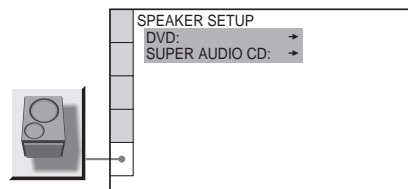

- 2 Select “DVD” or “SUPER AUDIO CD” using  $\uparrow/\downarrow$ , then press ENTER.

Example: when “DVD” is selected.

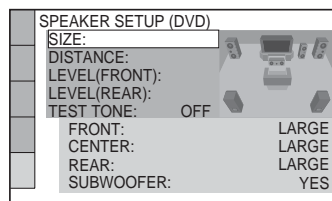

- 3 Set the following items in the order that they are explained below.

The default settings are underlined.

## To return to the default setting

Select the item, then press CLEAR. Note that only the “SIZE” setting does not return to the default setting.

### ◆ SIZE

Selects the size of the speakers.

#### • FRONT

<b>LARGE</b>	Normally select this position.
<b>SMALL</b>	Select this when the speaker cannot reproduce adequate bass frequencies.

#### • CENTER

<b>LARGE</b>	Normally select this position.
<b>SMALL</b>	Select this when the speaker cannot reproduce adequate bass frequencies.
<b>NONE</b>	Select this if you do not connect a center speaker.

#### • REAR

<b>LARGE</b>	Normally select this position.
<b>SMALL</b>	Select this when the speaker cannot reproduce adequate bass frequencies.
<b>NONE</b>	Select this if you do not connect rear speakers.

#### • SUBWOOFER

<b>YES</b>	Select this if you connect a subwoofer to output the LFE (low frequency effect) signals from the subwoofer.
<b>NONE</b>	Select this if you do not connect a subwoofer.

## Notes

- The cut off frequency for the subwoofer is fixed at 120 Hz.
- If your speakers are too small to reproduce low bass frequencies, utilize a subwoofer for low frequency sound. When you set all speaker settings to “SMALL,” the bass redirection circuitry will be activated and the bass frequencies for the speakers are output from the subwoofer.
- Even if there are fewer than 6 speakers connected, the player distributes the audio signal components to the front speakers.

### ◆ DISTANCE

Sets the distance from your listening position to the speakers.

Set the distance to your front speakers in “FRONT” first (A). Then adjust the values in “CENTER” (center speaker B), “REAR” (rear speakers C), and “SUBWOOFER” (D) to reflect the actual distance to your center speaker, rear speakers, and subwoofer.

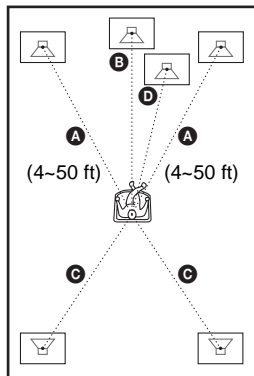

Be sure to change the value in the Setup Display when you move the speakers. The default adjustments are in parentheses.

<b>FRONT</b> (10 ft)	Set this between 4 and 50 feet in 0.25 foot increments.
<b>CENTER</b> (10 ft)	Set this within $\pm 6$ feet of the “FRONT” setting in 0.25 foot increments. For example, if “FRONT” is set to 6 feet, “CENTER” can be set between 0 and 12 feet.
<b>REAR</b> (10 ft)	Set this within $-18$ and $+6$ feet of the “FRONT” setting in 0.25 foot increments. For example, if “FRONT” is set to 18 feet, “REAR” can be set between 0 and 24 feet.
<b>SUBWOOFER</b> (10 ft)	Set this within $-18$ and $+6$ feet of the “FRONT” setting in 0.25 foot increments. For example, if “FRONT” is set to 18 feet, “REAR” can be set between 0 and 24 feet.

## Note

If each of the front or rear speakers are not placed at an equal distance from your listening position, set the distance according to the closest speaker.

### ◆ LEVEL (FRONT)

Varies the level of the front speakers. Be sure to set "TEST TONE" to "ON" for easy adjustment.

The default adjustments are in parentheses.

L (0 dB)	Set this between -6 dB and 0 dB in 0.5 dB increments.
R (0 dB)	Set this between -6 dB and 0 dB in 0.5 dB increments.
CENTER (0 dB)	Set this between -12 dB and 0 dB in 0.5 dB increments.
SUBWOOFER (DVD: -5 dB/ SUPER AUDIO CD: 0 dB)	For DVDs: (When "SIZE" are set to the default settings): Set this between -10 dB and +10 dB in 0.5 dB increments. (When "SIZE" are not set to the default settings): Set this between -15 dB and +5 dB in 0.5 dB increments. For Super Audio CDs: Set this between -10 dB and +10 dB in 0.5 dB increments.

### ◆ LEVEL (REAR)

Varies the level of the rear speakers. Be sure to set "TEST TONE" to "ON" for easy adjustment.

The default adjustments are in parentheses.

L (0 dB)	Set this between -12 dB and 0 dB in 0.5 dB increments.
R (0 dB)	Set this between -12 dB and 0 dB in 0.5 dB increments.

### To adjust the volume of all the speakers at one time

Use the amplifier's (receiver's) volume control.

### ◆ TEST TONE

The speakers will emit a test tone. Use this when you use the 5.1CH OUTPUT jacks and adjust "LEVEL (FRONT)" and "LEVEL (REAR)."

OFF	The test tone is not emitted from the speakers.
ON	The test tone is emitted from each speaker in sequence while adjusting balance or level.

## Adjusting the speaker volume and level

- 1 Select "SPEAKER SETUP" in the Setup Display.
- 2 Select "TEST TONE" and set to "ON."  
You will hear the test tone from each speaker in sequence.
- 3 From your listening position, select "LEVEL (FRONT)" or "LEVEL (REAR)" and adjust the value using  $\uparrow/\downarrow$ .  
The test tone is emitted from both left and right speakers simultaneously.
- 4 Select "TEST TONE" and set to "OFF" to turn off the test tone.

## Note

The test tone signals are not output from the digital jack.

## Troubleshooting

If you experience any of the following difficulties while using the player, use this troubleshooting guide to help remedy the problem before requesting repairs. Should any problem persist, consult your nearest Sony dealer.

### Power

**The power is not turned on.**

- ➔ Check that the AC power cord is connected securely.

### Picture

**There is no picture/picture noise appears.**

- ➔ Re-connect the connecting cord securely.
- ➔ The connecting cords are damaged.
- ➔ Check the connection to your TV (page 18) and switch the input selector on your TV so that the signal from the player appears on the TV screen.
- ➔ The disc is dirty or flawed.
- ➔ If the picture output from your player goes through your VCR to get to your TV or if you are connected to a combination TV/VIDEO player, the copy-protection signal applied to some DVD programs could affect picture quality. If you still experience problems even when you connect your player directly to your TV, please try connecting your player to your TV's S VIDEO input (page 18).
- ➔ You have set "COMPONENT OUT" in "SCREEN SETUP" to "PROGRESSIVE" even though your TV cannot accept the signal in progressive format. In this case, set the COMPONENT VIDEO OUT/SCAN SELECT switch on the rear panel of the player to INTERLACE. Then reset the COMPONENT VIDEO OUT/SCAN SELECT switch to SELECTABLE (page 72).
- ➔ Even if your TV is compatible with progressive format 480p signals, the image may be affected when you set "COMPONENT OUT" to "PROGRESSIVE." In this case, set "COMPONENT OUT" to "INTERLACE."

- ➔ You have selected VIDEO OFF (page 31).

**Even though you set the aspect ratio in "TV TYPE" of "SCREEN SETUP," the picture does not fill the screen.**

- ➔ The aspect ratio of the disc is fixed on your DVD.

### Sound

**There is no sound.**

- ➔ Re-connect the connecting cord securely.
- ➔ The connecting cord is damaged.
- ➔ The player is connected to the wrong input jack on the amplifier (receiver) (page 23, 24, 25).
- ➔ The amplifier (receiver) input is not correctly set.
- ➔ The player is in pause mode or in Slow-motion Play mode.
- ➔ The player is in fast forward or fast reverse mode.
- ➔ If the audio signal does not come through the DIGITAL OUT (OPTICAL or COAXIAL) jack, check the audio settings (page 75).
- ➔ Super Audio CD audio signals are not output from the digital jack.
- ➔ While playing a Super VCD on which the audio track 2 is not recorded, no sound will come out when you select "2:STEREO," "2:1/L," or "2:2/R."

**Sound distortion occurs.**

- ➔ Set "AUDIO ATT" in "AUDIO SETUP" to "ON" (page 74).

**The sound volume is low.**

- ➔ The sound volume is low on some DVDs. The sound volume may improve if you set "AUDIO DRC" to "TV MODE" (page 74).
- ➔ Set "AUDIO ATT" in "AUDIO SETUP" to "OFF" (page 74).

**The surround effect is difficult to hear when you are playing a Dolby Digital or DTS sound track.**

- ➔ Check the speaker connections and setting (page 25, 27, 75).
- ➔ The 5.1 channel sound is not recorded on the disc being played.

---

The sound comes from the center speaker only.

- ➔ Depending on the disc, the sound may come from the center speaker only.

---

## Operation

The remote does not function.

- ➔ There are obstacles between the remote and the player.
- ➔ The distance between the remote and the player is too far.
- ➔ The remote is not pointed at the remote sensor on the player.
- ➔ The batteries in the remote are weak.
- ➔ The command mode setting on the remote does not match the setting on the player (page 17).

---

The disc does not play.

- ➔ The disc is turned over.  
Insert the disc with the playback side facing down on the disc tray.
- ➔ The disc is skewed.
- ➔ The player cannot play certain discs (page 6).
- ➔ The region code on the DVD does not match the player.
- ➔ Moisture has condensed inside the player (page 3).
- ➔ The player cannot play a recorded disc that is not correctly finalized (page 7).

---

The MP3 audio track cannot be played (page 39).

- ➔ The DATA CD is not recorded in the MP3 format that conforms to ISO9660 Level 1/ Level 2 or Joliet.
- ➔ The MP3 audio track does not have the extension “.MP3.”
- ➔ The data is not formatted in MP3 even though it has the extension “.MP3.”
- ➔ The data is not MPEG1 Audio Layer 3 data.
- ➔ The player cannot play audio tracks in MP3PRO format.

---

“Copyright lock” appears and the screen turns blue when playing a DVD-RW disc.

- ➔ Images taken from digital broadcasts, etc., may contain copy protection signals, such as complete copy protection signals, single copy signals, and restriction-free signals. When images that contain copy protection signals are played, a blue screen may appear instead of the images. It may take a while when looking for playable images.

---

The title of the MP3 audio album or track is not correctly displayed.

- ➔ The player can only display numbers and alphabet. Other characters are displayed as “\*.”

---

The disc does not start playing from the beginning.

- ➔ Program Play, Shuffle Play, Repeat Play, or A-B Repeat Play has been selected (page 41).
- ➔ Resume play has taken effect (page 34).

---

The player starts playing the disc automatically.

- ➔ The disc features an auto playback function.
- ➔ “AUTO PLAY” in “CUSTOM SETUP” is set to “ON” (page 73).

---

Playback stops automatically.

- ➔ While playing discs with an auto pause signal, the player stops playback at the auto pause signal.

---

You cannot perform some functions such as Stop, Search, Slow-motion Play, Repeat Play, Shuffle Play, or Program Play.

- ➔ Depending on the disc, you may not be able to do some of the operations above. See the operating manual that comes with the disc.

---

The language for the sound track cannot be changed.

- ➔ Try using the DVD’s menu instead of the direct selection button on the remote (page 35).
- ➔ Multilingual tracks are not recorded on the DVD being played.
- ➔ The DVD prohibits the changing of the language for the sound track.



The subtitle language cannot be changed or turned off.

- ➔ Try using the DVD's menu instead of the direct selection button on the remote (page 35).
- ➔ Multilingual subtitles are not recorded on the DVD being played.
- ➔ The DVD prohibits the changing of the subtitles.

The angles cannot be changed.

- ➔ Try using the DVD's menu instead of the direct selection button on the remote (page 35).
- ➔ Multi-angles are not recorded on the DVD being played.
- ➔ The angle can only be changed when the "ANGLE" indicator lights up on the front panel display (page 10).
- ➔ The DVD prohibits changing of the angles.

The player does not operate properly.

- ➔ When static electricity, etc., causes the player to operate abnormally, unplug the player.

Nothing is displayed on the front panel display.

- ➔ "DIMMER" in "CUSTOM SETUP" is set to "OFF" or "AUTO OFF." Set "DIMMER" to any setting other than "OFF" or "AUTO OFF" (page 73).

5 numbers or letters are displayed on the screen and on the front panel display.

- ➔ The self-diagnosis function was activated. (See the table on page 81.)

The disc tray does not open and "LOCKED" appears on the front panel display.

- ➔ Child Lock is set (page 33).

The disc tray does not open and "TRAY LOCKED" appears on the front panel display.

- ➔ Contact your Sony dealer or local authorized Sony service facility.

"Data error" appears on the TV screen when playing a DATA CD.

- ➔ The MP3 audio track you want to play is broken.
- ➔ The data is not MPEG1 Audio Layer 3 data.

## Self-diagnosis Function

(When letters/numbers appear in the display)

When the self-diagnosis function is activated to prevent the player from malfunctioning, a five-character service number (e.g., C 13 50) with a combination of a letter and four digits appears on the screen and the front panel display. In this case, check the following table.

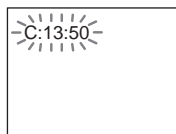

First three characters of the service number	Cause and/or corrective action
C 13	The disc is dirty. ➔ Clean the disc with a soft cloth (page 8).
C 31	The disc is not inserted correctly. ➔ Re-insert the disc correctly.
E XX (xx is a number)	To prevent a malfunction, the player has performed the self-diagnosis function. ➔ Contact your nearest Sony dealer or local authorized Sony service facility and give the 5-character service number. Example: E 61 10

---

## Glossary

### **Chapter (page 10)**

Sections of a picture or a music feature that are smaller than titles. A title is composed of several chapters. Depending on the disc, no chapters may be recorded.

---

### **Dolby Digital (page 25, 75)**

Digital audio compression technology developed by Dolby Laboratories. This technology conforms to multi-channel surround sound. The rear channel is stereo and there is a discrete subwoofer channel in this format. Dolby Digital provides the same discrete channels of high quality digital audio found in “Dolby Digital” theater surround sound systems. Good channel separation is realized because all of the channel data are recorded discretely and little deterioration is realized because all channel data processing is digital.

## Index (CD)/Video Index (VIDEO CD) (page 10)

A number that divides a track into sections to easily locate the point you want on a CD or VIDEO CD. Depending on the disc, no index may be recorded.

## Interlace format (page 72)

Interlace format shows every other line of an image as a single “field” and is the standard method for displaying images on television. The even number field shows the even numbered lines of an image, and the odd numbered field shows the odd numbered lines of an image.

## Progressive conversion method (page 59)

- Video based software conversion  
Video shows an image by alternately displaying every other line of an image (field) at 30 frames (60 fields) per second (Interlace format).



The Interlace format displays 30 frames (60 fields) per second by displaying every other line of the image, causing scanning lines to appear across the image. Furthermore, since only half of the image is shown at once, the amount of information contained in an image is limited.



The Progressive format displays 60 entire frames per seconds. The player accomplishes this by converting each field into a frame by using either a field-based conversion method or a frame-based conversion method. The appropriate method is automatically selected by the player according to the movement of the images on the screen. If the movement on the screen is slow, the frame-based conversion method borrows adjacent field information to fill in the missing information. If the movement on the screen is rapid, the field-based conversion method creates the missing information by predicting the movement of the images on the screen from

field to field. The end result is an image that is higher in quality when compared to the Interlace format.

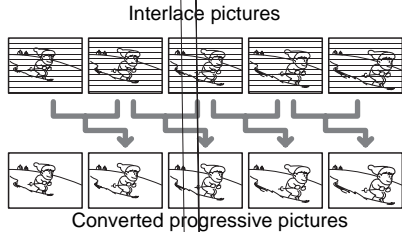

- Film based software conversion  
Film shows an image by displaying an entire image at 24 frames per second. When you watch a film on television, the television displays every other line of the frame as a field, thus reducing information level and the clarity of the film image.

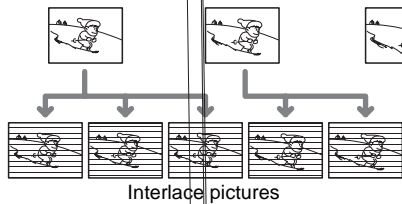

This player solves this problem by increasing the speed at which the frames are displayed, consecutively showing 3 identical frames followed by 2 identical frames in the time that it normally takes to show 2 consecutive frames. The end result is that the 24 frames per second are increased to 60 frames per second, which is the speed at which Progressive video signals are shown.

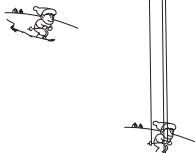

This not only allows film to be shown in a frame based format, it also increases the clarity and sharpness which is unique to Progressive format images.

---

### Progressive format (page 72)

Compared to the Interlace format that alternately shows every other line of an image (field) to create one frame, the Progressive format shows the entire image at once as a single frame. This means that while the Interlace format can show 30 frames (60 fields) in one second, the Progressive format can show 60 frames in one second. The overall picture quality increases and still images, text, and horizontal lines appear sharper. This player is compatible with the 480 progressive format.

---

### Scene (page 10)

On a VIDEO CD with PBC (playback control) functions, the menu screens, moving pictures and still pictures are divided into sections called "scenes."

---

### Super Audio CD (page 6)

A Super Audio CD disc can reproduce sounds that are extremely faithful to the original sound by use of DSD (Direct Stream Digital) technology. This technology utilizes a sampling frequency of 2.8224 MHz, which is 64 times that of a conventional CD, and 1-bit quantization that enables the disc to hold 4 times the amount of information that a standard PCM format CD can hold. Super Audio CDs are divided into the following types.

- Super Audio CD (single layer disc)

This disc consists of a single HD layer\*.

\*High density signal layer for the Super Audio CD



- Super Audio CD (dual layer disc)

This disc consists of dual HD layers and is capable of extended play over long periods. Also, as the dual layer disc consists of dual HD layers on one side only, you do not have to turn the disc over during playback.

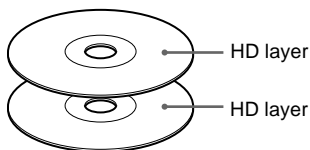

- Super Audio CD + CD (Hybrid disc)

This disc consists of an HD layer and a CD layer. Also, as the dual layers are on one side only, you do not have to turn the disc over during playback. You can play the CD layer using a conventional CD player.

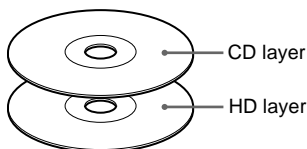

- 2 channel + Multi-channel Super Audio CD

This disc consists of the 2 channel playback area and the multi-channel playback area.

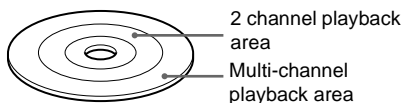

---

### Title (page 10)

The longest section of a picture or music feature on a DVD, movie, etc., in video software, or the entire album in audio software.

---

### Track (page 10)

Sections of a picture or a music feature on a CD or VIDEO CD (the length of a song).

# Specifications

## System

**Laser:** Semiconductor laser

**Signal format system:** NTSC

## Audio characteristics

**Frequency response:** DVD VIDEO (PCM 96 kHz): 2 Hz to 44 kHz (44 kHz: -2 dB  $\pm$  1 dB)/Super Audio CD: 2 Hz to 100 kHz (50 kHz: -3 dB  $\pm$  1 dB)/CD: 2 Hz to 20 kHz ( $\pm$ 0.5 dB)

**Harmonic distortion:** 0.003 %

**Dynamic range:** DVD VIDEO/Super Audio CD: 103 dB/CD: 99 dB

**Wow and flutter:** Less than detected value ( $\pm$ 0.001% W PEAK)

## Outputs

**(Jack name):** Jack type/Output level/Load impedance)

**AUDIO OUT 1/2:** Phono jack/2 Vrms/10 kilohms

**DIGITAL OUT (OPTICAL):** Optical output jack/-18 dBm (wave length: 660 nm)

**DIGITAL OUT (COAXIAL):** Phono jack/0.5 Vp-p/75 ohms

**5.1CH OUTPUT:** Phono jack/2 Vrms/10 kilohms

## COMPONENT VIDEO OUT(Y, P<sub>B</sub>, P<sub>R</sub>):

Phono jack/Y: 1.0 Vp-p/P<sub>B</sub>, P<sub>R</sub>:  
interlace\*=0.648 Vp-p, progressive or  
interlace\*\*=0.7 Vp-p/75 ohms

\* BLACK LEVEL is ON

\*\* BLACK LEVEL is OFF

**VIDEO OUT 1/2:** Phono jack/1.0 Vp-p/75 ohms

**S VIDEO OUT 1/2:** 4-pin mini DIN/Y:  
1.0 Vp-p, C: 0.286 Vp-p/75 ohms

## General

### Power requirements:

120 V AC, 60 Hz

### Power consumption:

24 W

### Dimensions (approx.):

430  $\times$  135.5  $\times$  432 mm (17  $\times$  5  $\frac{3}{8}$   $\times$  17  $\frac{1}{8}$  in.) (width/height/depth) incl. projecting parts

**Mass (approx.):** 8.2 kg (18  $\frac{5}{64}$  lb)

**Operating temperature:** 5  $^{\circ}$ C to 35  $^{\circ}$ C (41  $^{\circ}$ F to 95  $^{\circ}$ F)

**Operating humidity:** 25 % to 80 %

## Supplied accessories

See page 16.

Specifications and design are subject to change without notice.

ENERGY STAR<sup>®</sup> is a U.S. registered mark. As an ENERGY STAR<sup>®</sup> Partner, Sony Corporation has determined that this product meets the ENERGY STAR<sup>®</sup> guidelines for energy efficiency.

# Language Code List

For details, see pages 54, 57, 70.

The language spellings conform to the ISO 639: 1988 (E/F) standard.

Code Language	Code Language	Code Language	Code Language
1027 Afar	1183 Irish	1347 Maori	1507 Samoan
1028 Abkhazian	1186 Scots Gaelic	1349 Macedonian	1508 Shona
1032 Afrikaans	1194 Galician	1350 Malayalam	1509 Somali
1039 Amharic	1196 Guarani	1352 Mongolian	1511 Albanian
1044 Arabic	1203 Gujarati	1353 Moldavian	1512 Serbian
1045 Assamese	1209 Hausa	1356 Marathi	1513 Siswati
1051 Aymara	1217 Hindi	1357 Malay	1514 Sesotho
1052 Azerbaijani	1226 Croatian	1358 Maltese	1515 Sundanese
1053 Bashkir	1229 Hungarian	1363 Burmese	1516 Swedish
1057 Byelorussian	1233 Armenian	1365 Nauru	1517 Swahili
1059 Bulgarian	1235 Interlingua	1369 Nepali	1521 Tamil
1060 Bihari	1239 Interlingue	1376 Dutch	1525 Telugu
1061 Bislama	1245 Inupiak	1379 Norwegian	1527 Tajik
1066 Bengali;	1248 Indonesian	1393 Occitan	1528 Thai
Bangla	1253 Icelandic	1403 (Afan)Oromo	1529 Tigrinya
1067 Tibetan	1254 Italian	1408 Oriya	1531 Turkmen
1070 Breton	1257 Hebrew	1417 Punjabi	1532 Tagalog
1079 Catalan	1261 Japanese	1428 Polish	1534 Setswana
1093 Corsican	1269 Yiddish	1435 Pashto;	1535 Tonga
1097 Czech	1283 Javanese	Pushto	1538 Turkish
1103 Welsh	1287 Georgian	1436 Portuguese	1539 Tsonga
1105 Danish	1297 Kazakh	1463 Quechua	1540 Tatar
1109 German	1298 Greenlandic	1481 Rhaeto-	1543 Twi
1130 Bhutani	1299 Cambodian	Romance	1557 Ukrainian
1142 Greek	1300 Kannada	1482 Kirundi	1564 Urdu
1144 English	1301 Korean	1483 Romanian	1572 Uzbek
1145 Esperanto	1305 Kashmiri	1489 Russian	1581 Vietnamese
1149 Spanish	1307 Kurdish	1491 Kinyarwanda	1587 Volapük
1150 Estonian	1311 Kirghiz	1495 Sanskrit	1613 Wolof
1151 Basque	1313 Latin	1498 Sindhi	1632 Xhosa
1157 Persian	1326 Lingala	1501 Sangho	1665 Yoruba
1165 Finnish	1327 Laothian	1502 Serbo-	1684 Chinese
1166 Fiji	1332 Lithuanian	Croatian	1697 Zulu
1171 Faroese	1334 Latvian;	1503 Singhalese	
1174 French	Lettish	1505 Slovak	
1181 Frisian	1345 Malagasy	1506 Slovenian	1703 Not specified

# Index

## Numerics

16:9 71  
4:3 LETTER BOX 71  
4:3 OUTPUT 72  
4:3 PAN SCAN 71  
480p 72  
48kHz/96kHz PCM 76  
5.1 Channel Surround 21, 25

## A

A-B REPEAT 45  
ADVANCED 52  
Album 39  
ANGLE 57  
AUDIO 54, 70  
AUDIO ATT 74  
AUDIO DRC 74  
AUDIO FILTER 75  
AUDIO SETUP 74  
AUTO PLAY 73  
AUTO POWER OFF 73

## B

BACKGROUND 71  
Batteries 16  
BIT RATE 52  
BLACK LEVEL 71

## C

CD 31  
CD DIRECT 74  
CHAPTER 47  
Chapter 51, 82  
CHAPTER VIEWER 49  
Checking a disc loaded 32  
Child Lock 33  
Click shuttle 46  
COMMAND MODE 17  
COMPONENT OUT 72  
Connecting 18  
Continuous play  
DVD 31  
Super Audio CD/CD/  
VIDEO CD 31  
Control Menu 13  
CUSTOM 69  
CUSTOM PARENTAL  
CONTROL 62  
CUSTOM SETUP 73

## D

DATA CD 6, 38  
DIGITAL OUT 75  
Digital output 75  
DIMMER 73  
DISC SKIP 31  
Display  
Front panel display 10  
Setup Display 69  
Displaying the audio  
information of the disc 55  
DISTANCE 77  
DOLBY DIGITAL 25, 54,  
75, 82  
DOWNMIX 75  
DTS 25, 54, 75, 82  
DVD VIDEO 6, 31, 82  
DVD+RW 6, 32, 82  
DVD/CD text 50  
DVD's Menu 35  
DVD-RW 6, 35, 82

## F

Film based software 59, 82  
Freeze Frame 47  
Front panel display 10

## H

Handling discs 8  
Hooking up 16

## I

INDEX 47  
Index 83  
INSTANT REPLAY 32  
INSTANT SEARCH 32  
INTERLACE 72  
Interlace format 83

## J

Jog mode 47

## L

LANGUAGE SETUP 70  
LAYER 52  
Locating  
a specific point by watching  
the TV screen 46

## M

MEMORY 59  
MENU 70  
MP3 6, 38  
MULTI/2CH 36  
MULTI-DISC RESUME 34,  
74

## O

On-screen display  
Control Menu display 13  
Setup Display 69  
ORIGINAL 35  
ORIGINAL/PLAY LIST 35  
OSD 70

## P

PARENTAL CONTROL 63  
PAUSE MODE 73  
PBC Playback 37  
PICTURE NAVIGATION 49  
PLAY LIST 35  
PLAYBACK MEMORY 73  
PRO LOGIC 24, 75, 82  
PROGRAM 41  
Program Play 41  
PROGRESSIVE 72  
Progressive format 84

## Q

QUICK 70  
Quick Setup 27, 70

## R

Remote 16, 67  
REPEAT 44  
Repeat Play 44  
Replacing discs while playing  
a disc 33  
RESET 70  
Resume Play 34

## S

S VIDEO output 18  
SCENE 47  
Scene 84  
SCREEN SAVER 71  
SCREEN SETUP 71  
Searching 46  
Selecting a disc 32  
SETUP 69  
Setup Display 69  
SHUFFLE 43  
Shuffle Play 43  
Shuttle mode 46  
SIZE 77  
SPEAKER SETUP 76  
Speakers  
Hooking up 21  
STEP 47  
SUBTITLE 57, 70  
Super Audio CD 36, 84  
SURROUND 21, 56

## **T**

TEST TONE 78  
TIME/TEXT 47, 50  
TITLE 47  
Title 84  
TITLE VIEWER 49  
TOP MENU 35  
TRACK 47  
Track 10, 38, 84  
TRACK SELECTION 73  
TRACK VIEWER 49  
Troubleshooting 79  
TV TYPE 71

## **U**

Usable discs 6

## **V**

Video based software 59, 82  
VIDEO CD 31  
VIDEO CONTROL 58  
VIDEO OFF 31



Printed on 100% recycled paper using VOC (Volatile Organic Compound)-free vegetable oil based ink.